

Title: Lecture - Causal Inference, PHYS 777

Speakers: Robert Spekkens

Collection/Series: Causal Inference (Elective), PHYS 777, March 31 - May 2, 2025

Subject: Quantum Foundations

Date: April 04, 2025 - 11:30 AM

URL: <https://pirsa.org/25040037>

**Maximum wages
in future career
above some
threshold?**

**Degree from
educational
institution?**

	Yes	No
Yes	79%	21%
No	43%	57%

Coin
Flip

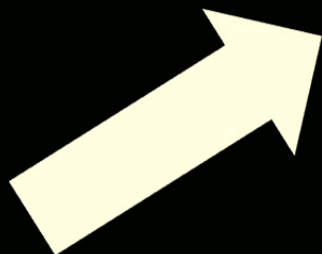

Degree from
educational
institution

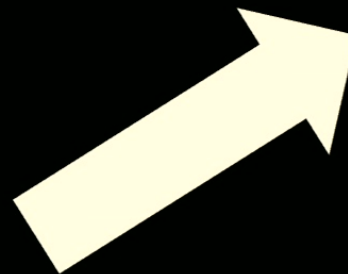

Maximum
wages in
future career

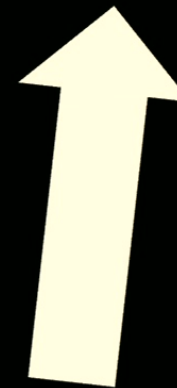

Hidden
factors such
as aptitude

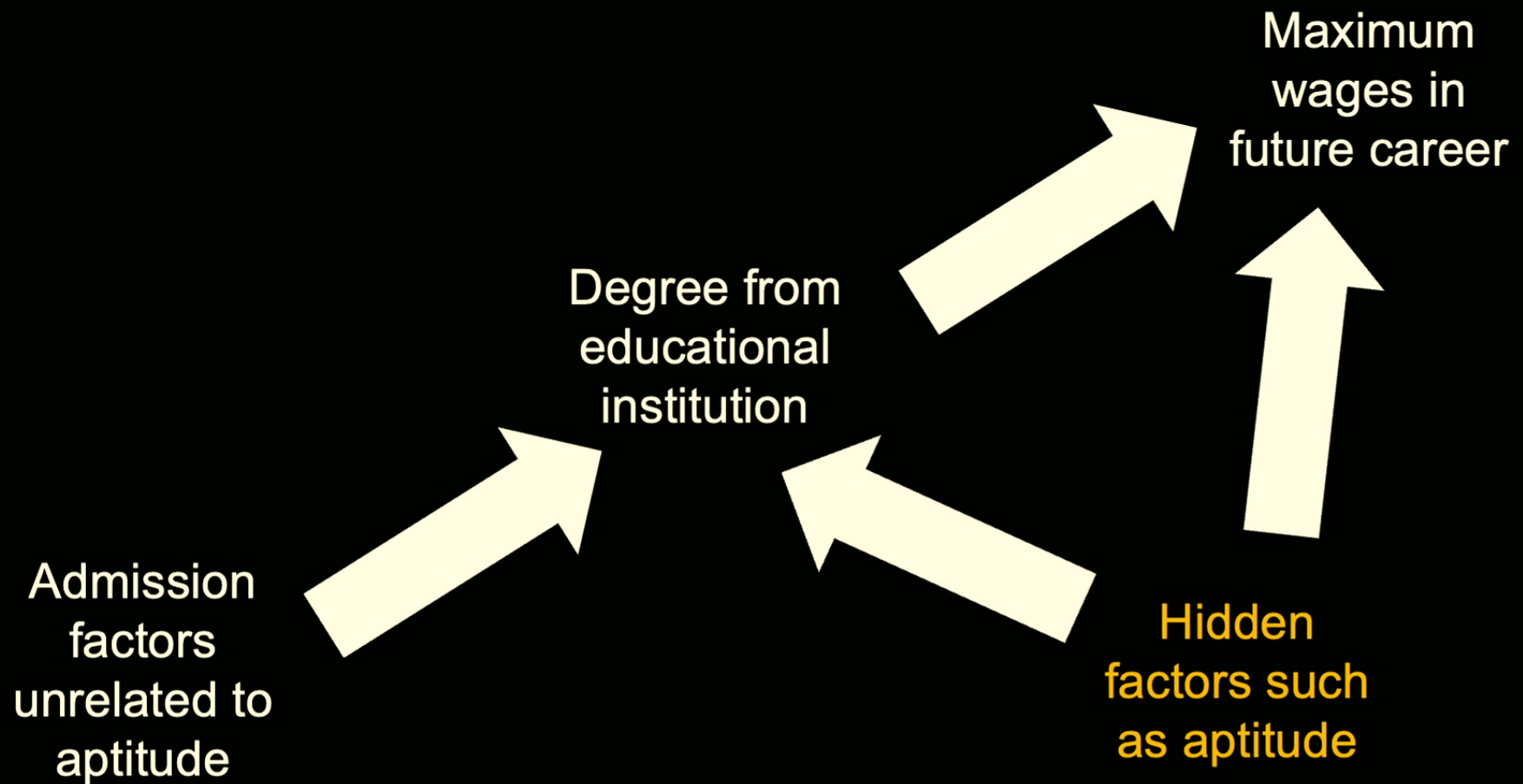

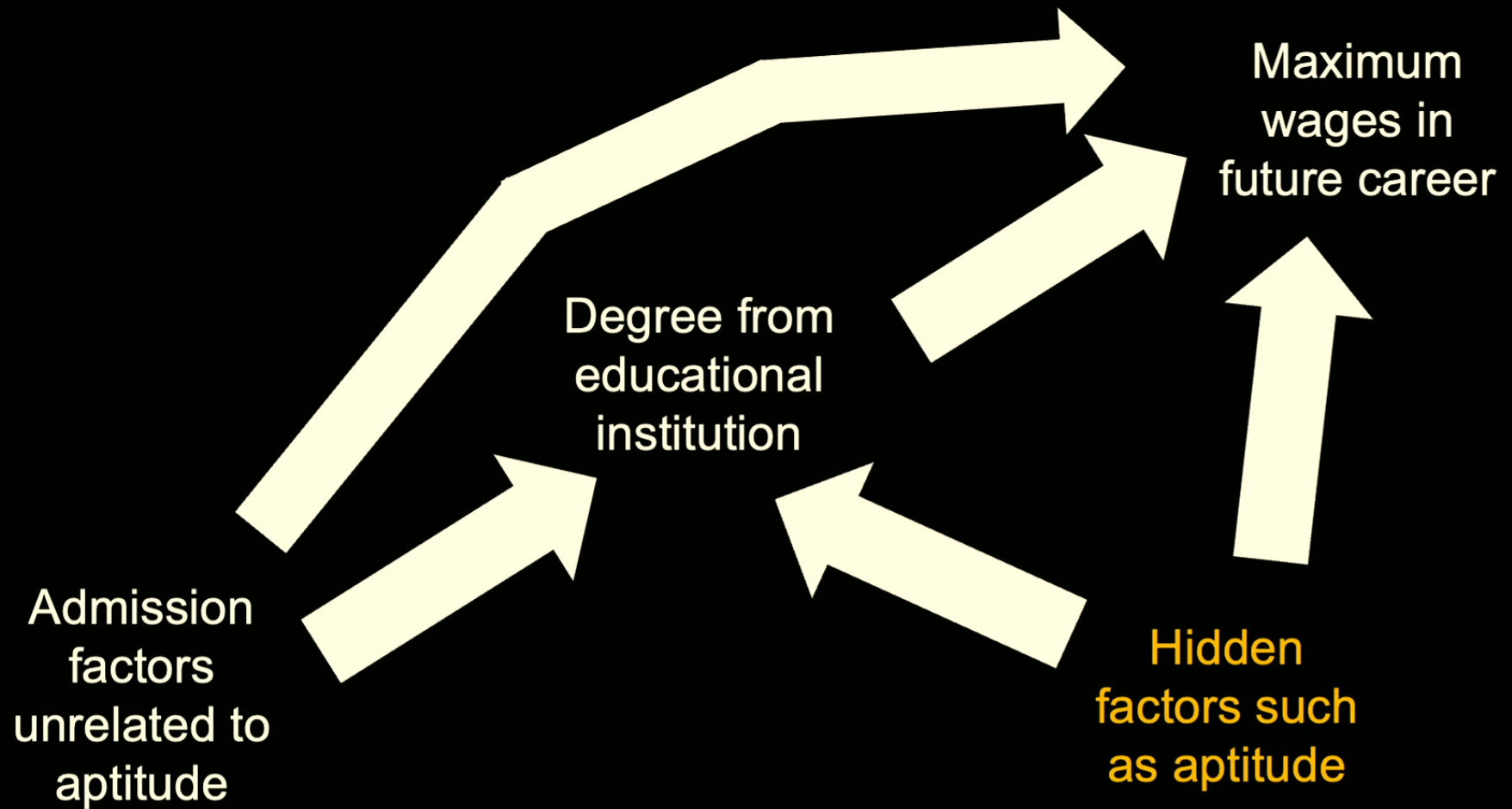

Causal structure

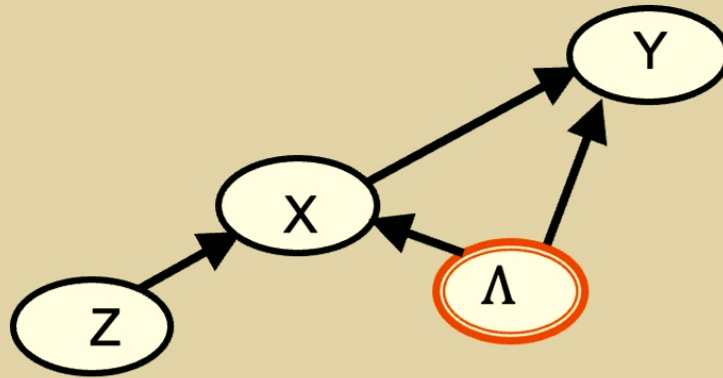

Parameters

$$P_{X|\Lambda Z}$$

$$P_{Y|\Lambda X}$$

$$P_{\Lambda}$$

$$P_Z$$

Causal structure

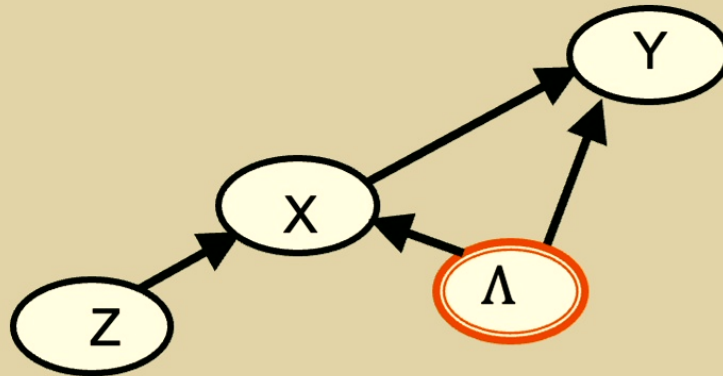

Parameters

$$P_{X|\Lambda Z}$$

$$P_{Y|\Lambda X}$$

$$P_{\Lambda}$$

$$P_Z$$

$$P_{XYZ} = \sum_{\Lambda} P_{Y|X\Lambda} P_{X|Z\Lambda} P_{\Lambda} P_Z$$

A distribution is said to be **compatible** with a given causal structure if there are parameters that yield it

Causal structure

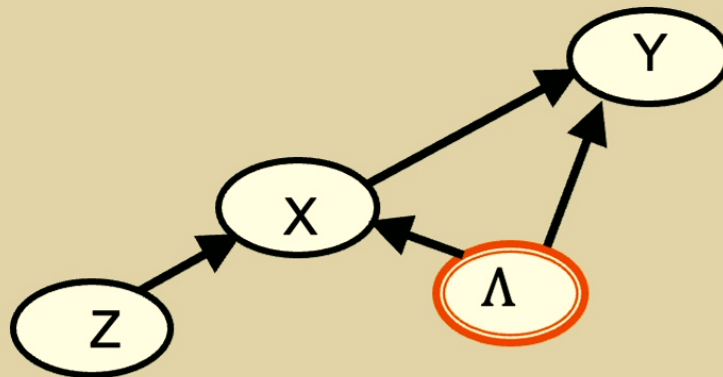

Parameters

$$P_{X|\Lambda Z}$$

$$P_{Y|\Lambda X}$$

$$P_{\Lambda}$$

$$P_Z$$

$$P_{XYZ} = \sum_{\Lambda} P_{Y|X\Lambda} P_{X|Z\Lambda} P_{\Lambda} P_Z$$

Example of causal compatibility constraint:

$$P_{XY|Z}(00|0) + P_{XY|Z}(01|1) \leq 1$$

Pearl, 1993

The evidence

		Z=0	
		Y=0	Y=1
Z=0	X=0	0.79	0.21
	X=1	0.43	0.57
		Z=1	
		Y=0	Y=1
Z=1	X=0	0.59	0.41
	X=1	0.39	0.61

Violates the instrumental inequality!

The hypotheses



Implies a constraint:
the instrumental inequality

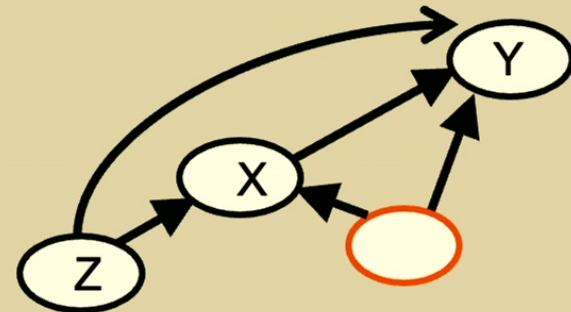

Bell's theorem

Left outcome



Left
setting

Right outcome



Right
setting

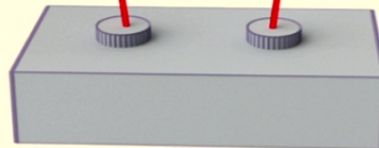

		Left outcome and Right outcome			
		0 and 0	0 and 1	1 and 0	1 and 1
Left setting and Right setting	0 and 0	43%	7%	7%	43%
	0 and 1	43%	7%	7%	43%
	1 and 0	43%	7%	7%	43%
	1 and 1	7%	43%	43%	7%

The evidence

		Left outcome and Right outcome			
		0 and 0	0 and 1	1 and 0	1 and 1
Left setting and Right setting	0 and 0	43%	7%	7%	43%
	0 and 1	43%	7%	7%	43%
	1 and 0	43%	7%	7%	43%
	1 and 1	7%	43%	43%	7%

Violates Bell inequalities
(up to Tsirelson bound)

The natural hypothesis

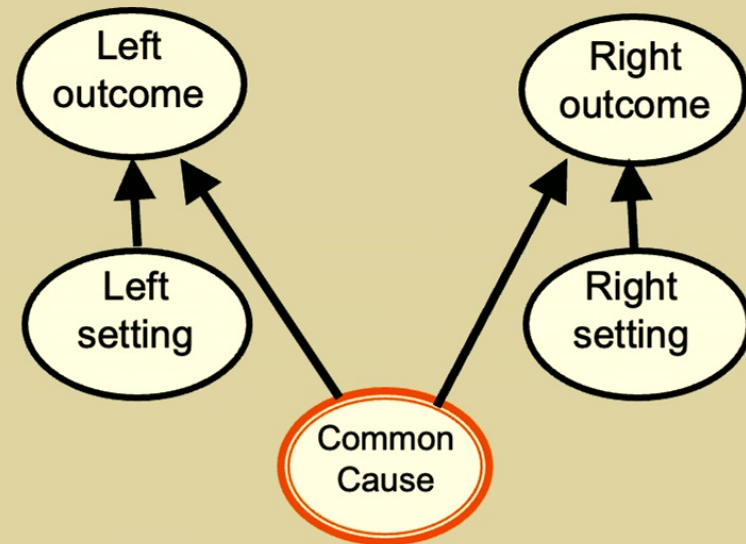

Implies Bell inequalities

Causal structure

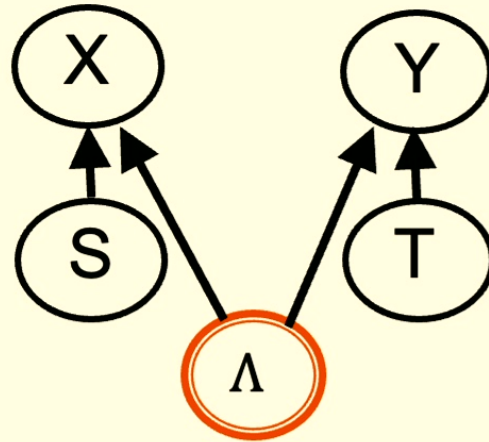

Parameters

$$P_{X|S\Lambda}$$
$$P_{Y|T\Lambda}$$
$$P_{\Lambda}$$

$$P_{XY|ST} = \sum_{\Lambda} P_{Y|T\Lambda} P_{X|S\Lambda} P_{\Lambda}$$

Examples of causal compatibility constraints:

$$P_{X|ST} = P_{X|S}$$
$$P_{Y|ST} = P_{Y|T}$$

$$\frac{1}{4} \sum_{x=y} P_{XY|ST}(xy|00) + \frac{1}{4} \sum_{x=y} P_{XY|ST}(xy|01) + \frac{1}{4} \sum_{x=y} P_{XY|ST}(xy|10) + \frac{1}{4} \sum_{x \neq y} P_{XY|ST}(xy|11) \leq \frac{3}{4}$$

Clauser, Horne, Shimony and Holte, Phys. Rev. Lett.23, 880 (1967)

The evidence

		Left outcome and Right outcome			
		0 and 0	0 and 1	1 and 0	1 and 1
Left setting and Right setting	0 and 0	43%	7%	7%	43%
	0 and 1	43%	7%	7%	43%
	1 and 0	43%	7%	7%	43%
	1 and 1	7%	43%	43%	7%

Violates the
Bell Inequalities!

The natural hypothesis

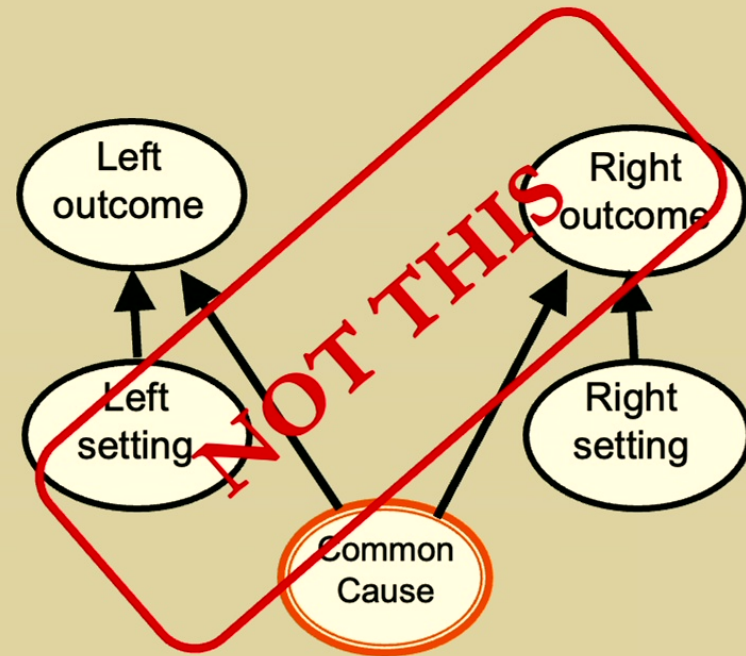

Implies a constraint:
Bell Inequalities

Incompatible

Causal structure

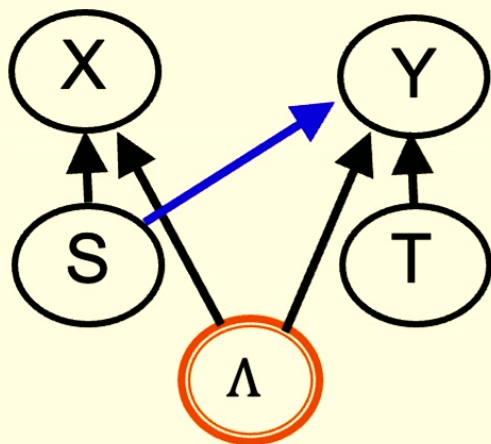

Parameters

$$P_{X|S\Lambda}$$
$$P_{Y|ST\Lambda}$$
$$P_{\Lambda}$$

$$P_{XY|ST} = \sum_{\Lambda} P_{Y|ST\Lambda} P_{X|S\Lambda} P_{\Lambda}$$

Causal compatibility constraints:

$$P_{X|ST} = P_{X|S}$$

But the data *also* satisfies $P_{Y|ST} = P_{Y|T}$

Causal structure

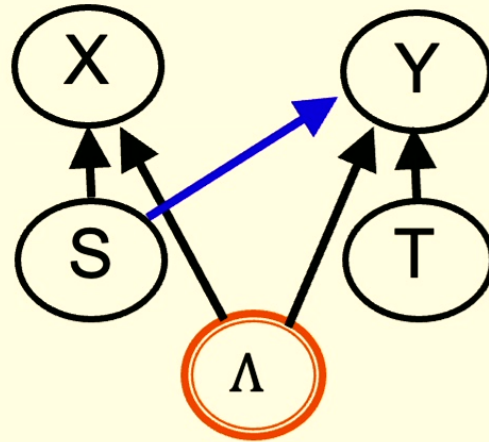

Parameters

$$P_{X|S\Lambda}$$
$$P_{Y|ST\Lambda}$$
$$P_{\Lambda}$$

$$P_{XY|ST} = \sum_{\Lambda} P_{Y|ST\Lambda} P_{X|S\Lambda} P_{\Lambda}$$

Causal compatibility constraints:

$$P_{X|ST} = P_{X|S}$$

But the data *also* satisfies $P_{Y|ST} = P_{Y|T}$

Reproducing this requires **fine-tuning**

Wood and RWS, New J. Phys. 17, 033002 (2015)

QUANTUM THEORY



Diego Delso / CC BY-SA

RELATIVITY

The evidence

		Left outcome and Right outcome			
		0 and 0	0 and 1	1 and 0	1 and 1
Left setting and Right setting	0 and 0	43%	7%	7%	43%
	0 and 1	43%	7%	7%	43%
	1 and 0	43%	7%	7%	43%
	1 and 1	7%	43%	43%	7%

The usual suspects

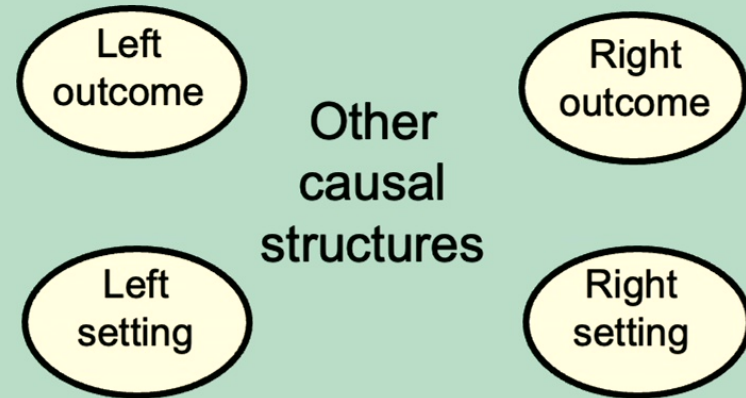

The evidence

		Left outcome and Right outcome			
		0 and 0	0 and 1	1 and 0	1 and 1
Left setting and Right setting	0 and 0	43%	7%	7%	43%
	0 and 1	43%	7%	7%	43%
	1 and 0	43%	7%	7%	43%
	1 and 1	7%	43%	43%	7%

The usual suspects

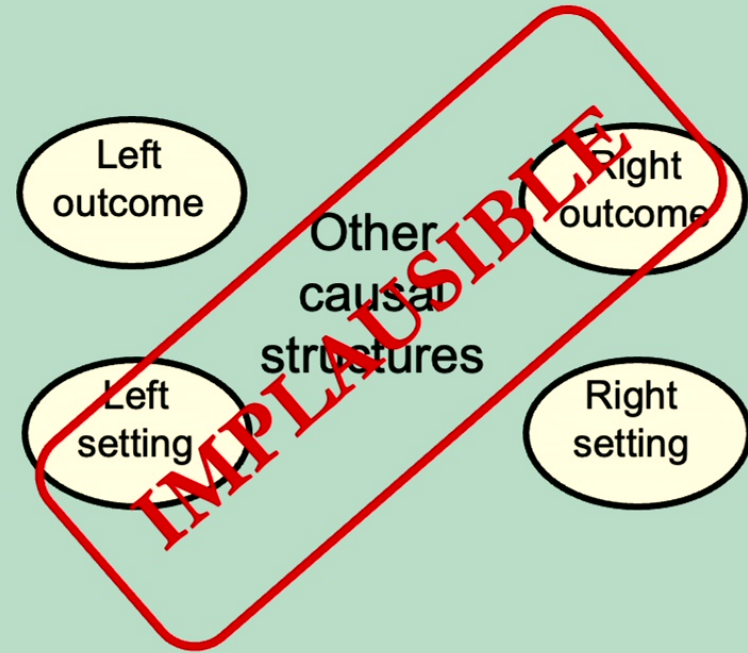

The evidence

		Left outcome and Right outcome			
		0 and 0	0 and 1	1 and 0	1 and 1
Left setting and Right setting	0 and 0	43%	7%	7%	43%
	0 and 1	43%	7%	7%	43%
	1 and 0	43%	7%	7%	43%
	1 and 1	7%	43%	43%	7%

A new possibility

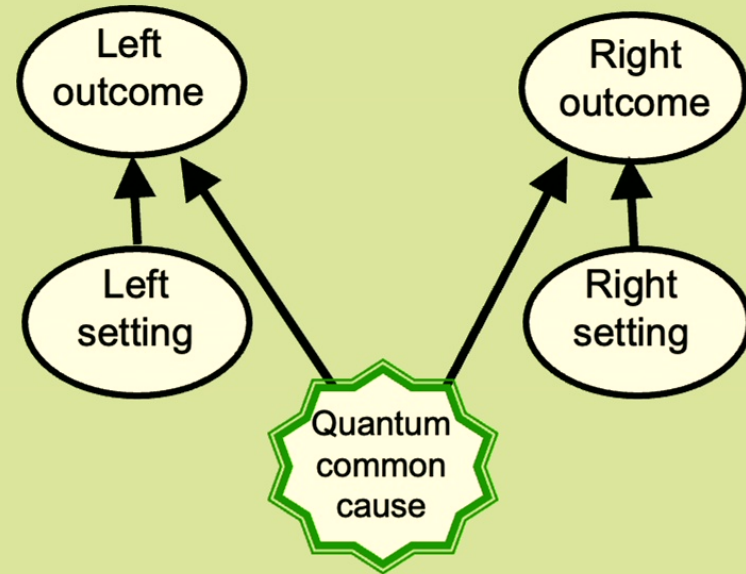

Causal structure

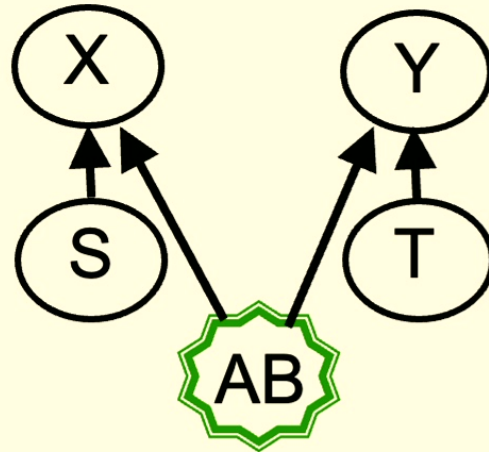

Parameters

$$\rho_{X|SA}$$

$$\rho_{Y|TB}$$

$$\rho_{AB}$$

$$P_{XY|ST} = \text{Tr}_{AB}(\rho_{X|SA}\rho_{Y|TB}\rho_{AB})$$

Causal compatibility constraints:

$$P_{X|ST} = P_{X|S}$$

$$P_{Y|ST} = P_{Y|T}$$

$$\frac{1}{4} \sum_{x=y} P_{XY|ST}(xy|00) + \frac{1}{4} \sum_{x=y} P_{XY|ST}(xy|01) + \frac{1}{4} \sum_{x=y} P_{XY|ST}(xy|10) + \frac{1}{4} \sum_{x \neq y} P_{XY|ST}(xy|11) \leq \underline{0.85}$$

Tsirelson, Lett. Math. Phys. 4, 93 (1980)

Causal structure

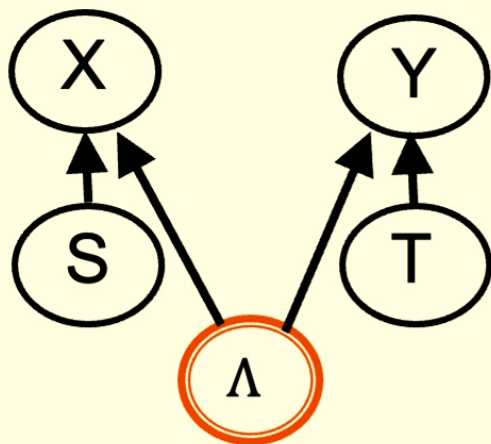

Parameters

$$P_{X|S\Lambda}$$
$$P_{Y|T\Lambda}$$
$$P_{\Lambda}$$

$$P_{XY|ST} = \sum_{\Lambda} P_{Y|T\Lambda} P_{X|S\Lambda} P_{\Lambda}$$

Examples of causal compatibility constraints:

$$P_{X|ST} = P_{X|S}$$

$$P_{Y|ST} = P_{Y|T}$$

The evidence

		Left outcome and Right outcome			
		0 and 0	0 and 1	1 and 0	1 and 1
Left setting and Right setting	0 and 0	43%	7%	7%	43%
	0 and 1	43%	7%	7%	43%
	1 and 0	43%	7%	7%	43%
	1 and 1	7%	43%	43%	7%

A new possibility

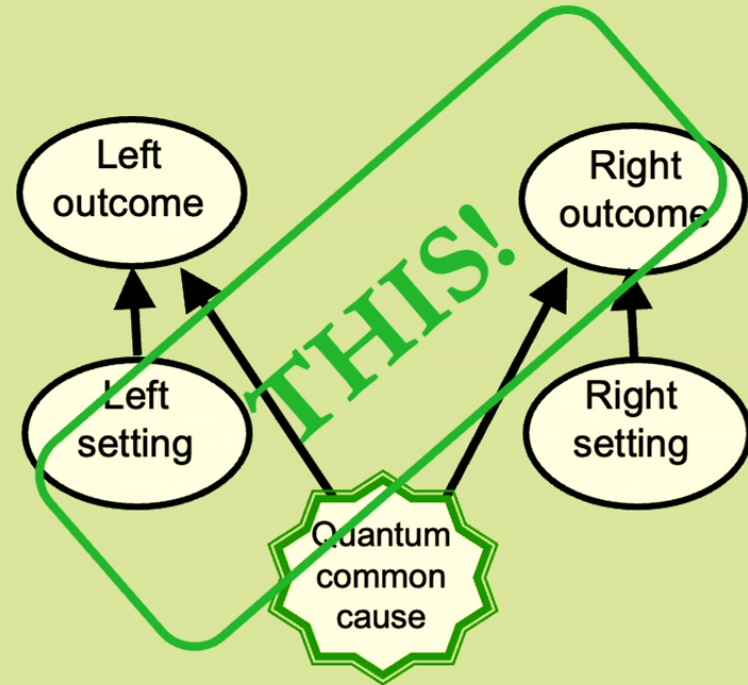

Compatible

Violation of Bell inequalities



Witnessing quantumness

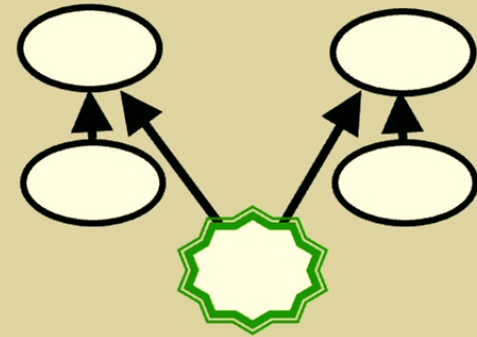

Violation of Bell inequalities



or



Witnessing need for different structure

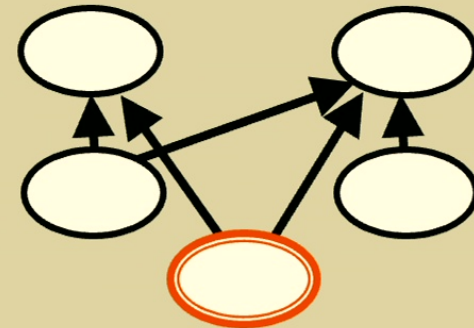

Witnessing quantumness

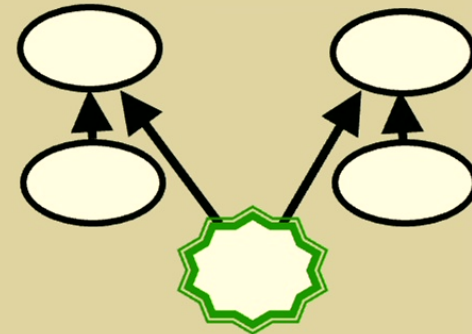

Violation of
Instrumental
Inequalities



or



Witnessing need for
different structure

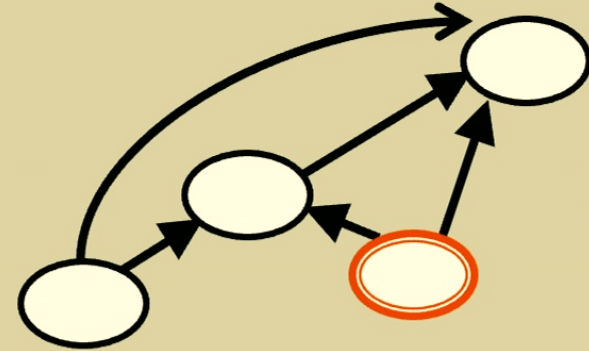

Witnessing
quantumness

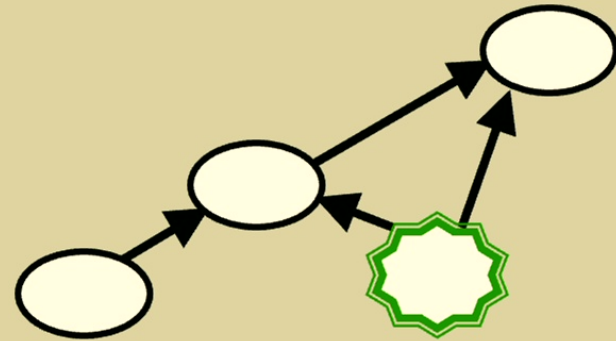

Some causal structures that admit of inequality constraints

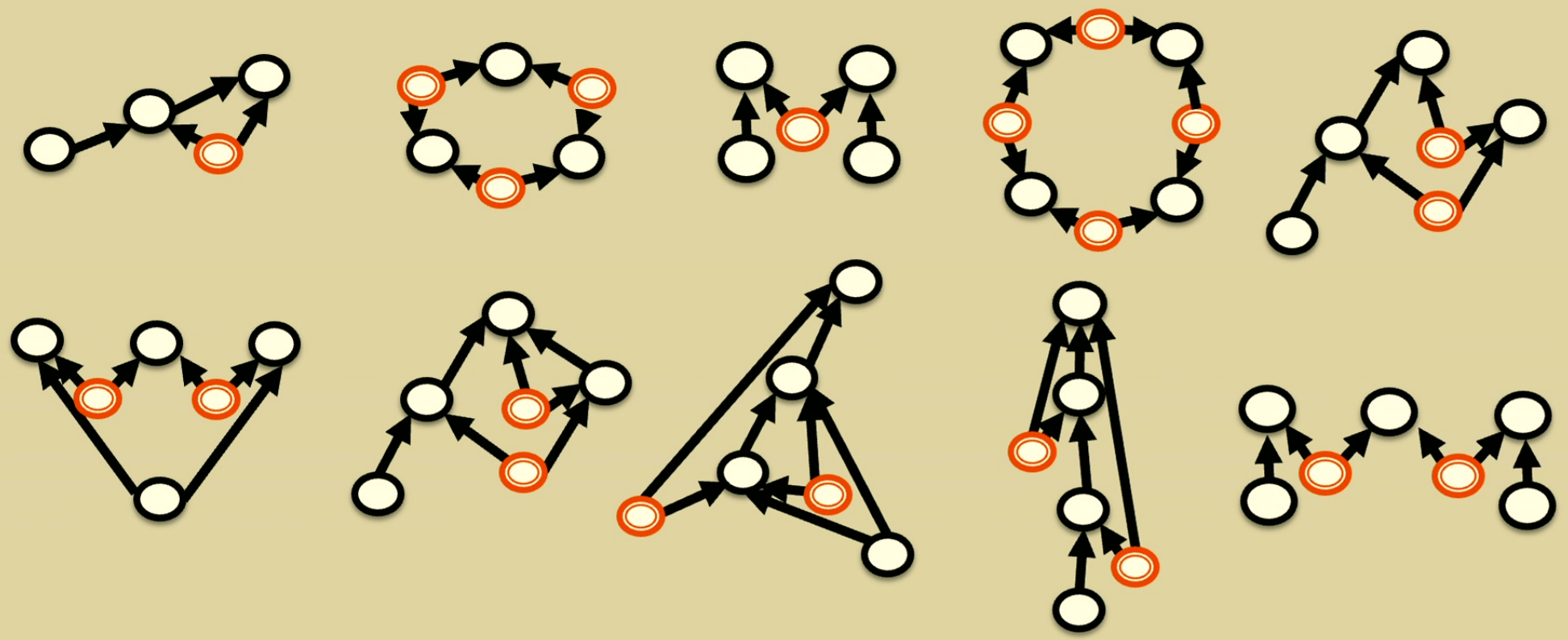

They are ubiquitous: Ansanelli, Wolfe, RWS, arXiv:2502.07891

Collaboration with experimental group of Fabio Sciarrino

Polino et al., Nature Communications 14, 909 (2023)

Targeting the quantum-classical gap described in:
 Fritz, New J. Phys. 14, 103001 (2012)

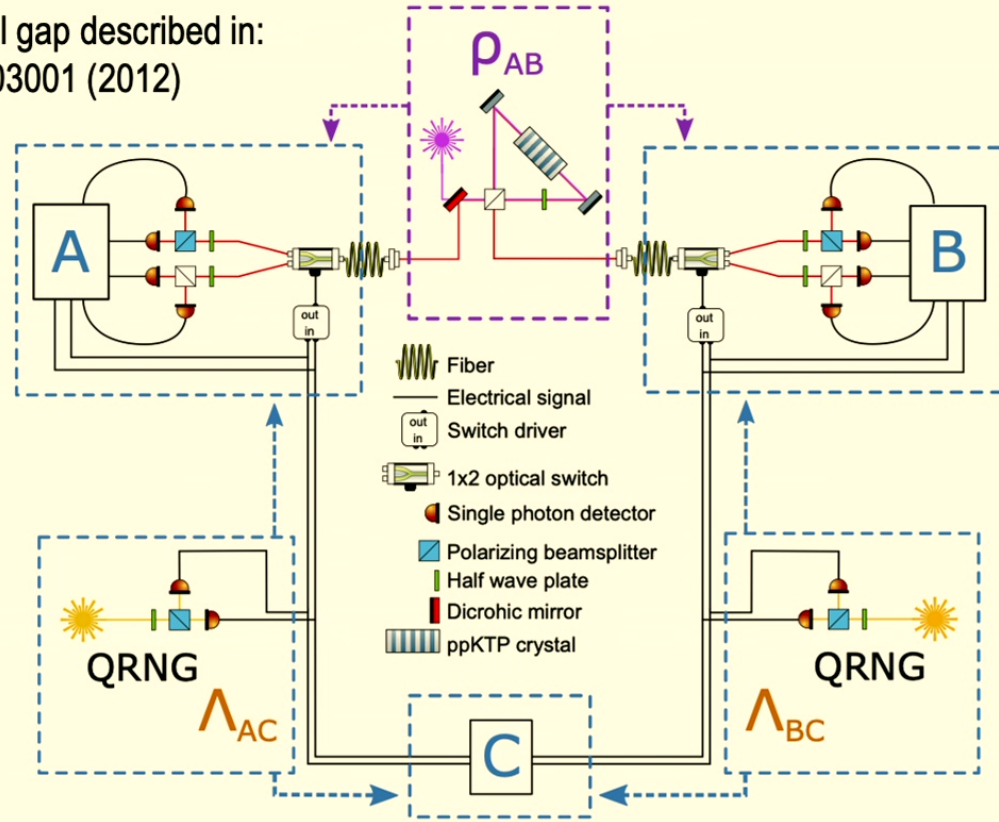
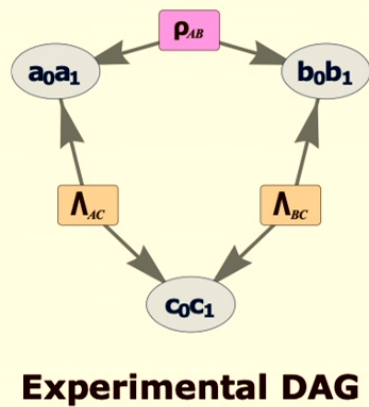

Violation of certain
causal compatibility
inequalities



or



Witnessing need for
different structure

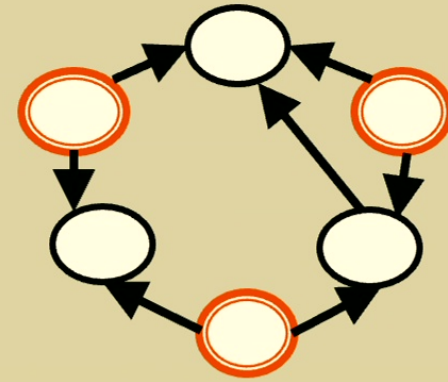

Witnessing
quantumness

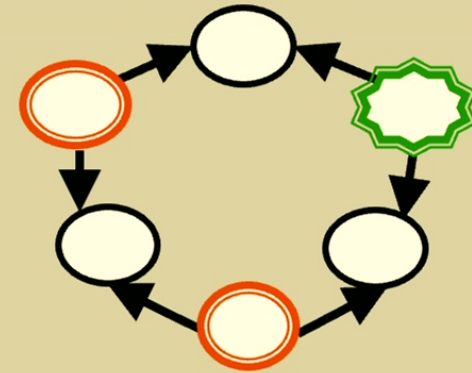

Data-seeded inflation technique

$$V := \sum_{a,b,c,a',b',c'} y_{abca'b'c'} P_{ABC}(abc) P_{ABC}(a'b'c') \geq 0$$

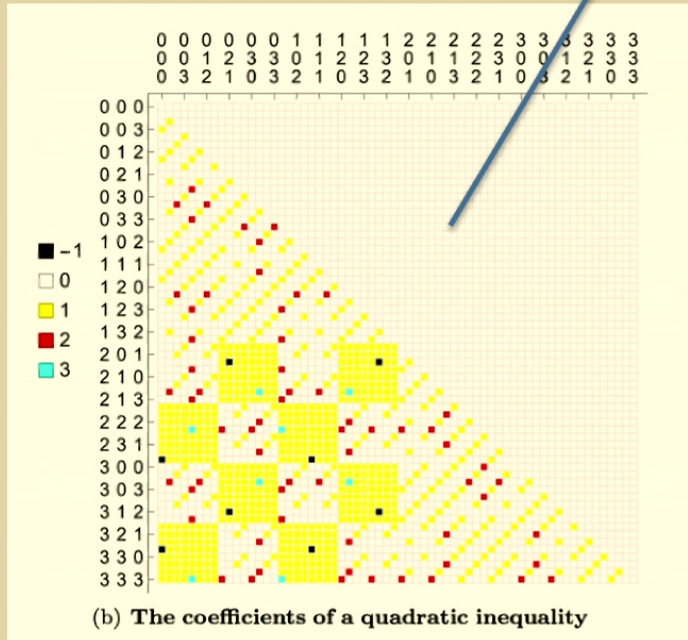

This causal compatibility inequality is violated by the data

$$V_{\text{exp}} = -0.02436 \pm 0.00016$$

Polino et al., Nature Communications 14, 909 (2023)



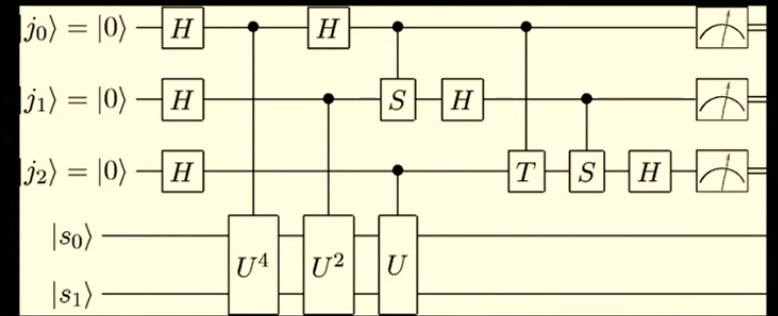
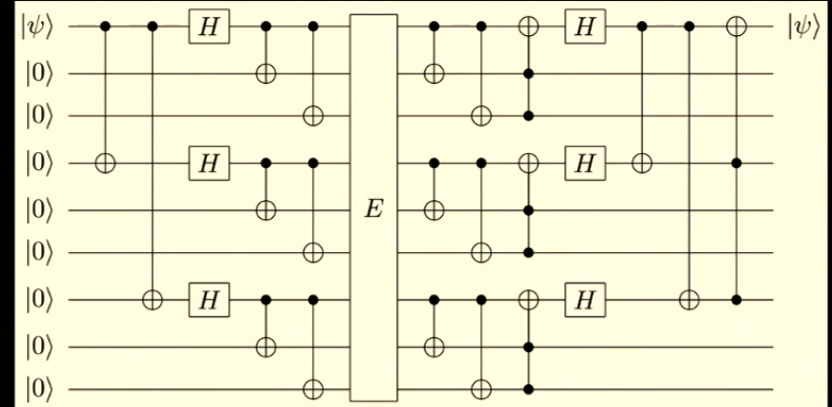
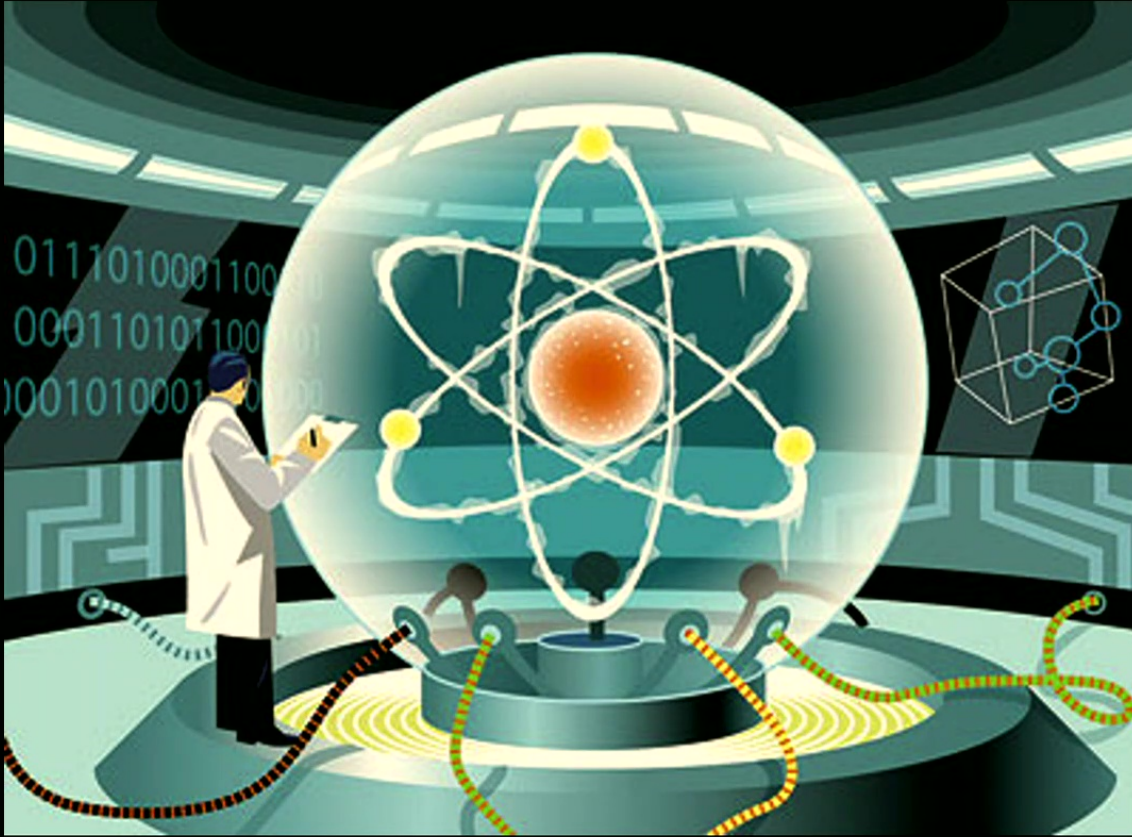

Quantum
Causation and Inference

Classical
Causation and Inference



Relativistic
Notions of Space
and Time

PreRelativistic
Notions of Space
and Time

How to define causation

Causal structure

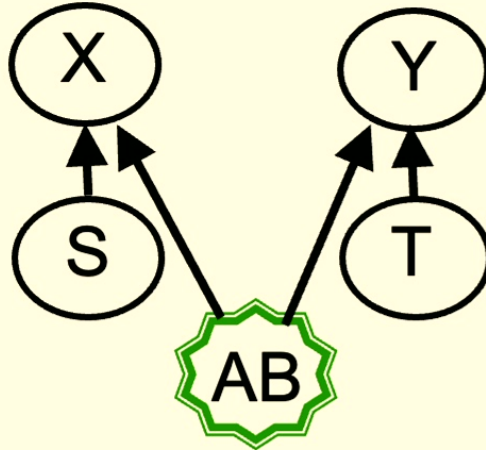

Parameters

$$\rho_{X|SA}$$

$$\rho_{Y|TB}$$

$$\rho_{AB}$$

$$P_{XY|ST} = \text{Tr}_{AB}(\rho_{X|SA}\rho_{Y|TB}\rho_{AB})$$

Causal compatibility constraints:

$$P_{X|ST} = P_{X|S}$$

$$P_{Y|ST} = P_{Y|T}$$

$$\frac{1}{4} \sum_{x=y} P_{XY|ST}(xy|00) + \frac{1}{4} \sum_{x=y} P_{XY|ST}(xy|01) + \frac{1}{4} \sum_{x=y} P_{XY|ST}(xy|10) + \frac{1}{4} \sum_{x \neq y} P_{XY|ST}(xy|11) \leq \underline{0.85}$$

Tsirelson, Lett. Math. Phys. 4, 93 (1980)

Some causal structures that admit of inequality constraints

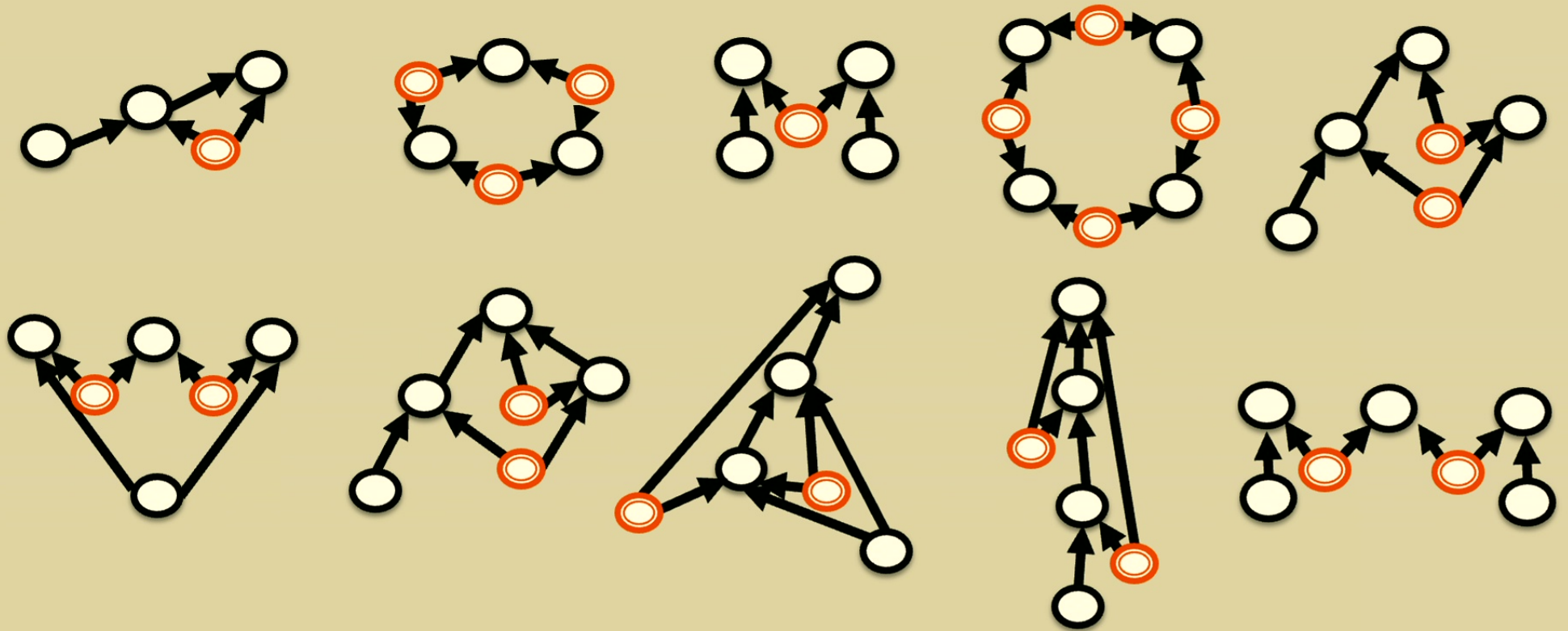

They are ubiquitous: Ansanelli, Wolfe, RWS, arXiv:2502.07891