

Title: Self-testing quantum supermaps, with an application to the quantum switch

Speakers: Alastair Abbott

Series: Quantum Foundations, Quantum Information

Date: September 16, 2024 - 4:27 PM

URL: <https://pirsa.org/24090144>

SELF-TESTING QUANTUM SUPERMAPS

WITH AN APPLICATION TO THE QUANTUM SWITCH

Victor Barizien, Alastair Abbott, Cyril Branciard,
Pavel Sekatski, Jean-Daniel Bancal

Causalworlds 2024



UNIVERSITÉ
DE GENÈVE



THE QUANTUM SWITCH SUPERMAP

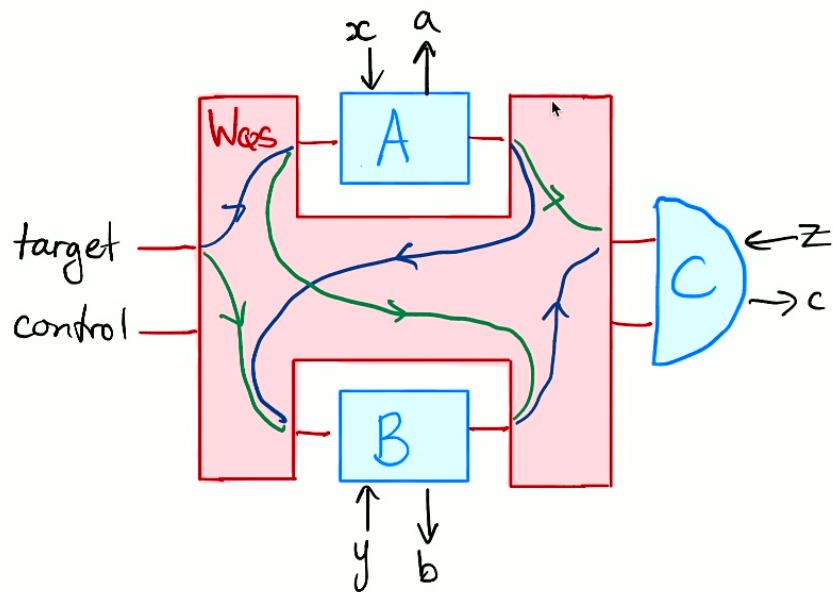

- Cannot violate any causal inequality
- DI certification in "network" scenarios

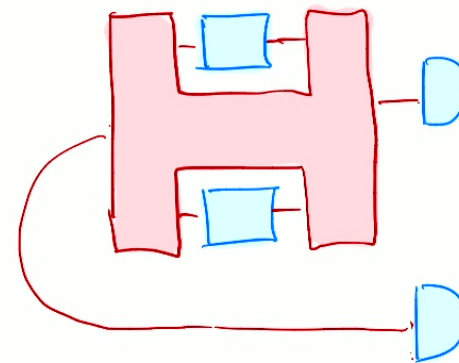

[van der Lugt, Barrett, Chiribella, 2023]
 [Gogioso, Pinzani, 2023]
 [Dourdent, Abbott, Šupić, Branciard, 2023]

- "Causally nonseparable" supermap

What can we certify from the correlations alone (black-box setting)?

- Self-testing??

SELF-TESTING

States

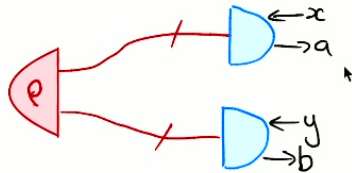

$$\langle CHSH \rangle = 2\sqrt{2} \Rightarrow \exists \Lambda_A, \Lambda_B$$

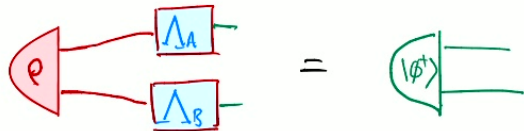
s.t. 

Channels

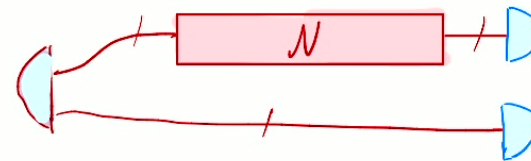

$$p(\cdot | \cdot) \Rightarrow \exists \Lambda_I, \Lambda_E$$

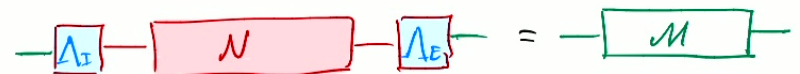
s.t. 

[Sekatski, Bancal, Wagner, Sangouard, 2018]

Supermaps

- 1) What scenario to self-test the Quantum Switch?
- 2) What kind of self-testing statement?

SELF-TESTING THE QUANTUM SWITCH

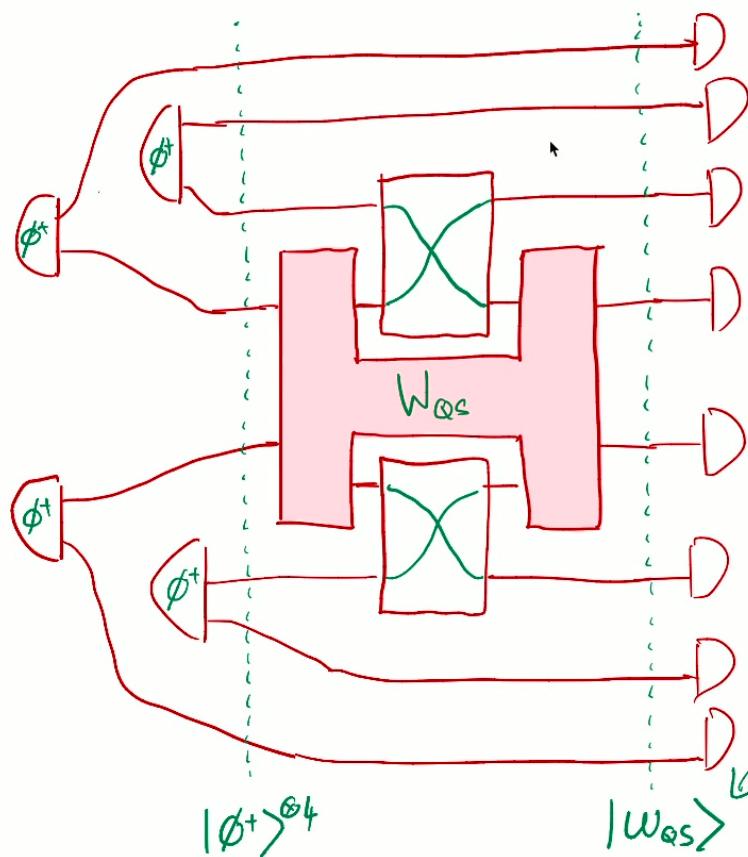

- Combine self tests of input and output states to derive a self-test of the QS.

Choi state of the quantum switch!

SELF-TESTING THE QUANTUM SWITCH

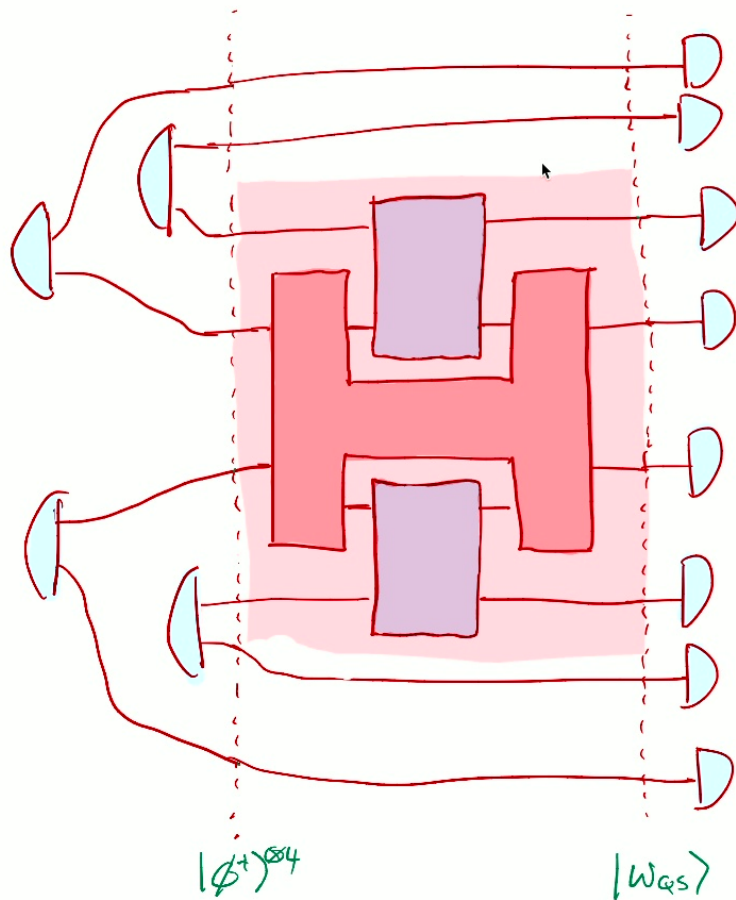

- Combine self tests of input and output states to derive a self-test of the QS.

- 1) Self-test $|\phi^+\rangle^{\otimes 4}$ at inputs
 - 2) Self-test $|W_{QS}\rangle$ at outputs
- ↳ Self-test of the channel $W_{QS}(\text{SWAP}, \text{SWAP})$

[Sekatski, Bancal, Wagner, Sangouard, 2018]

SELF-TESTING THE QUANTUM SWITCH

- 1) Self-test $|\phi^+\rangle^{\otimes 4}$ at inputs
 - 2) Self-test $|W_{\text{es}}\rangle$ at outputs
- ↳ Self-test of the channel $W_{\text{es}}(\text{SWAP}, \text{SWAP})$

\exists channels

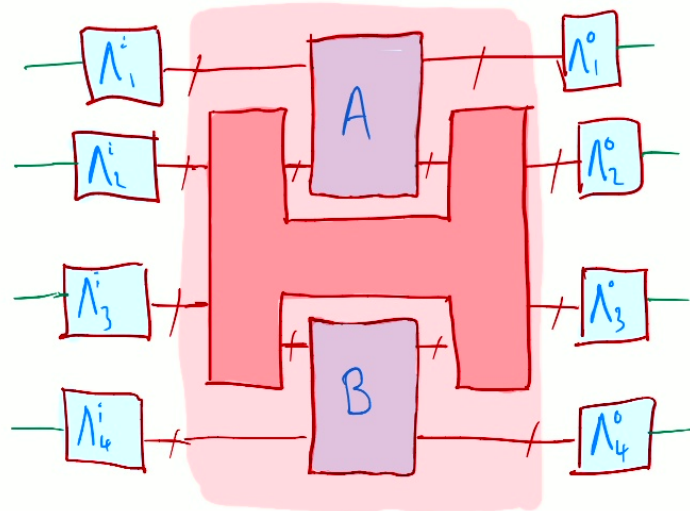
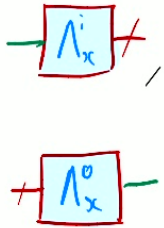

=

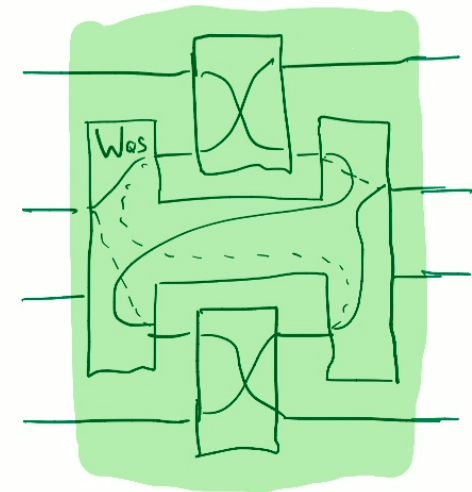

SELF-TESTING THE QUANTUM SWITCH

- 1) Self-test $|\Phi^+\rangle^{\otimes 4}$ at inputs
 - 2) Self-test $|W_{QS}\rangle$ at outputs
- ↳ Self-test of the channel $W_{QS}(\text{SWAP}, \text{SWAP})$
- ↳ Deduce a self-test of the Quantum Switch

∃ channels

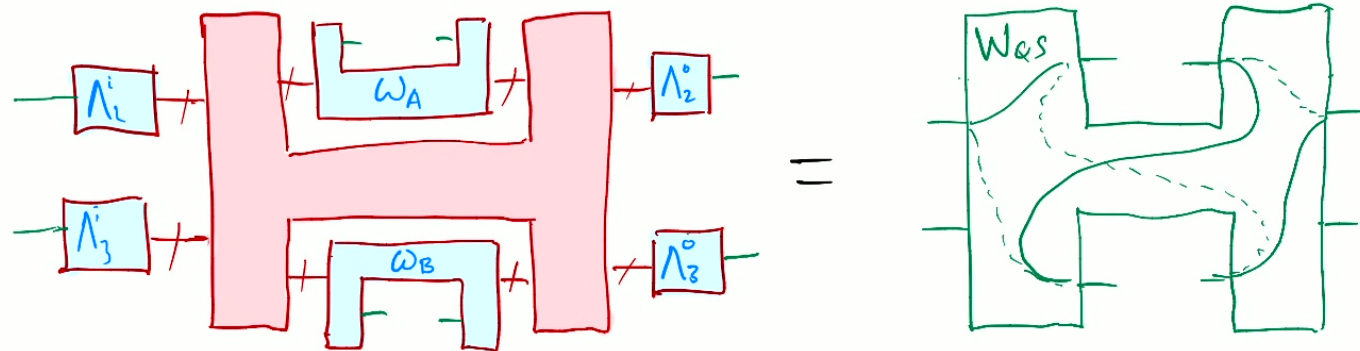
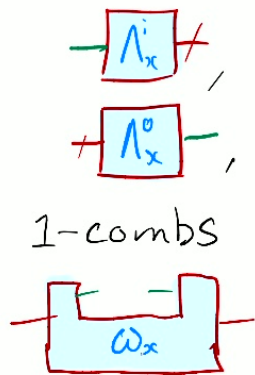

AND MORE...

- Why only self-test up to local combs?
- Can do better if we assume more structure!

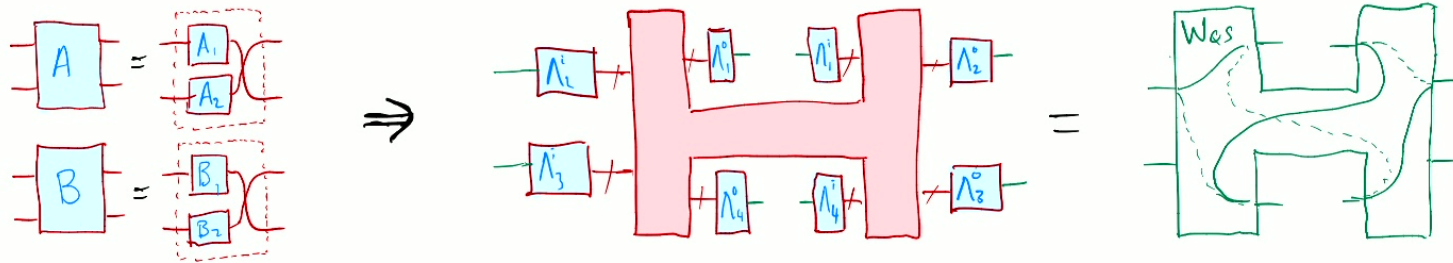

- Can self-test other supermaps, e.g. combs
- Which supermaps can be self-tested?
 - Lugano?
- How to interpret an experimental self-test?