

Title: General Relativity, Black Holes and GPS

Date: Jul 15, 2006 09:00 AM

URL: <http://pirsa.org/06070034>

Abstract:

Twin paradox

Consider two twins. One day, one of them decides to go on

What are the spacetime intervals for the two paths?

$s=cT$

$$s' = 2\sqrt{\left(\frac{cT}{2}\right)^2 - d^2}$$

$$= cT\sqrt{1 - \left(\frac{2d}{cT}\right)^2}$$

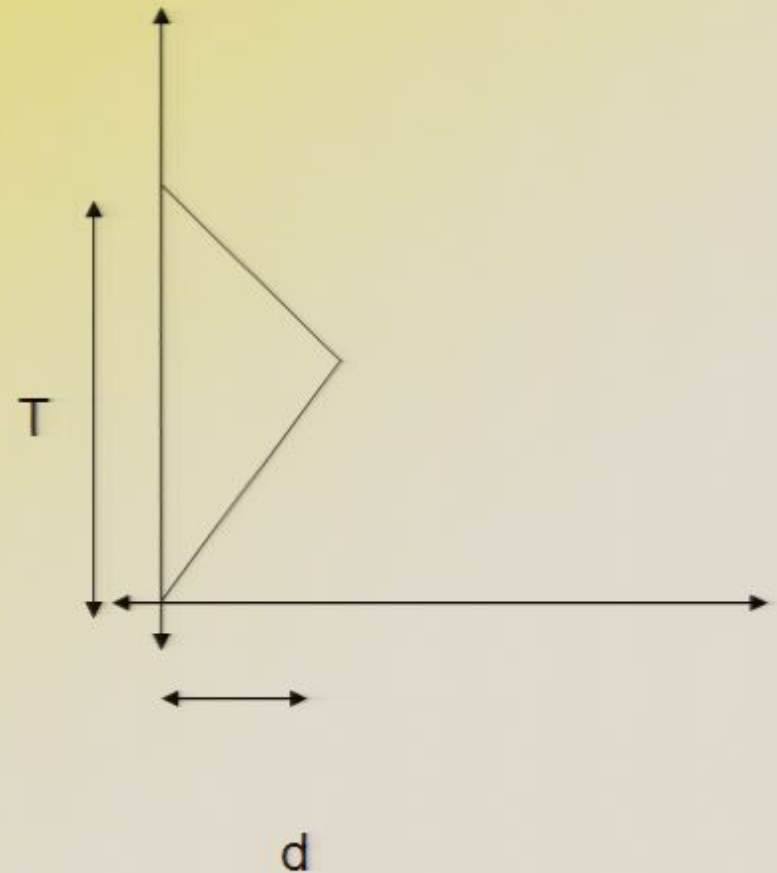



EARTH



STAR



EARTH



STAR

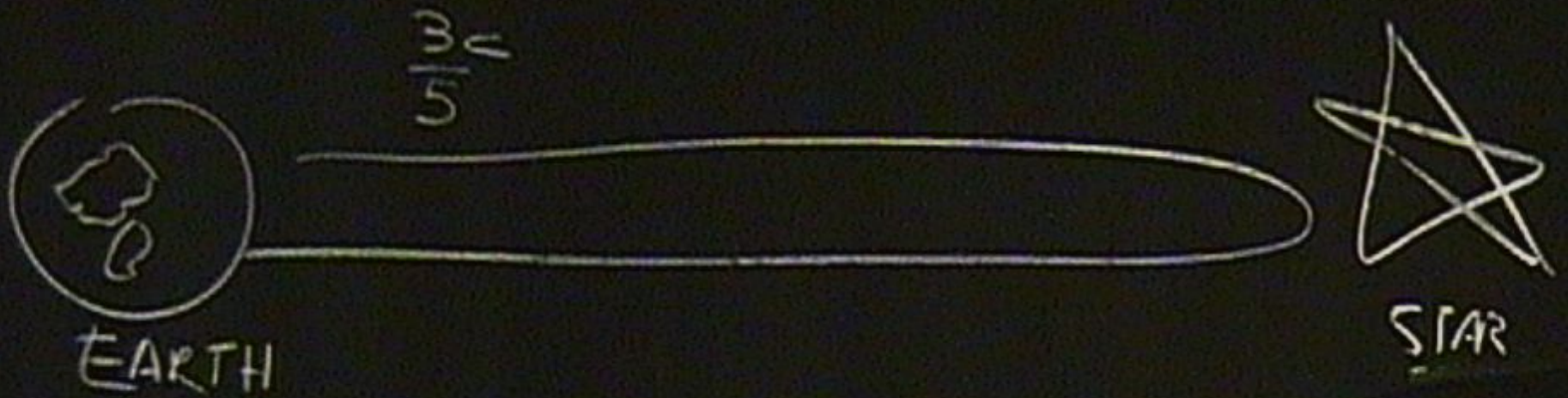

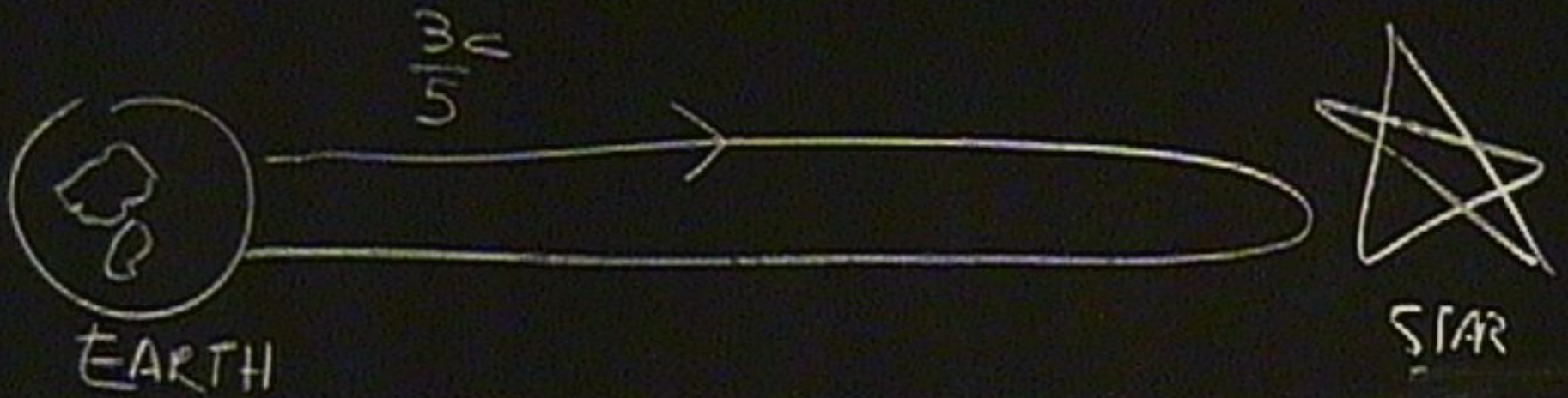

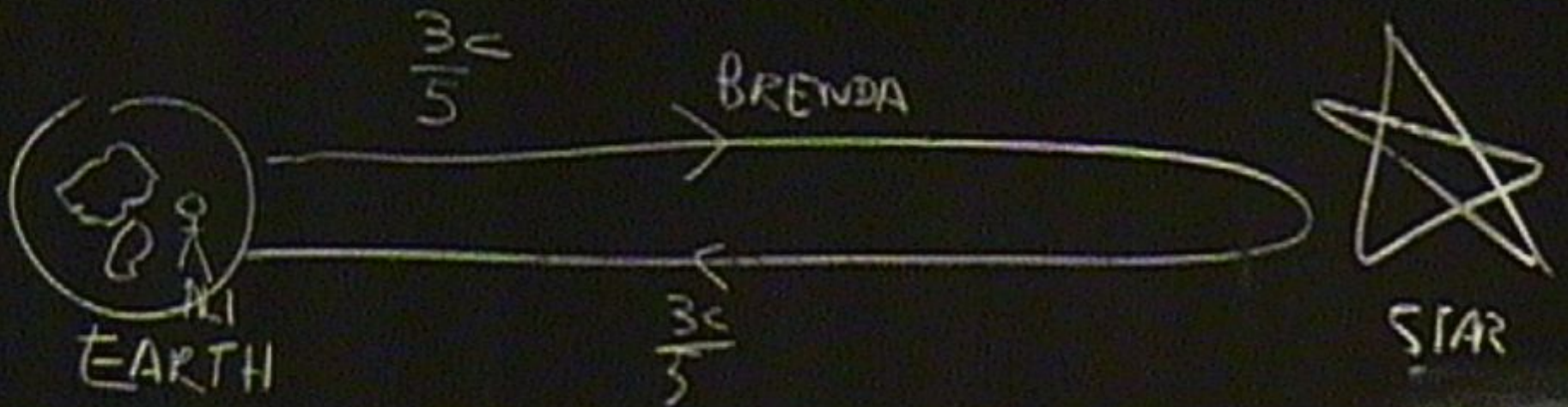

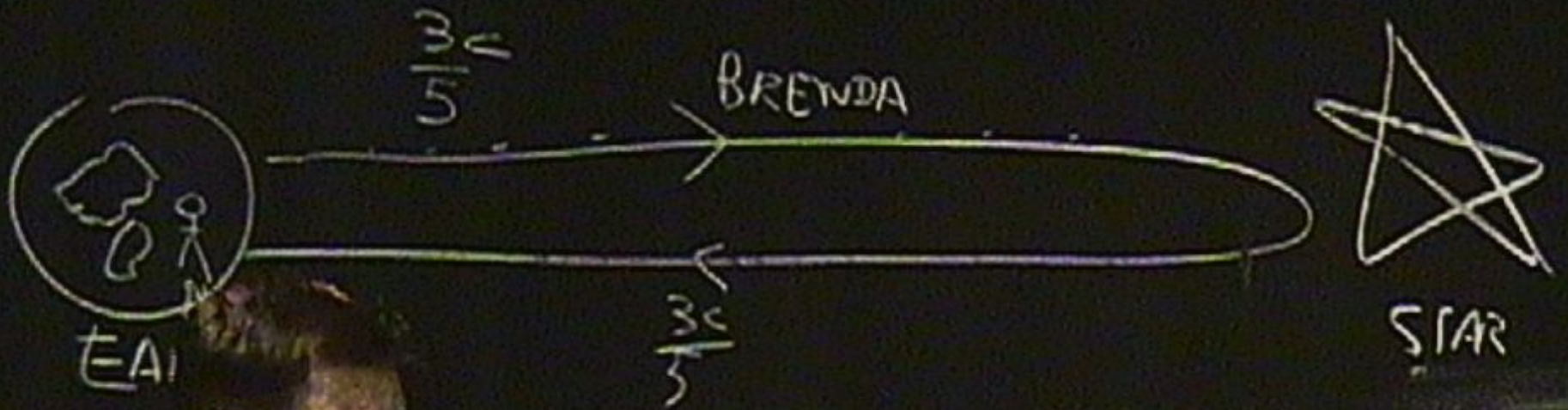

$$S^2 = (ct)^2 - (\Delta X)^2$$

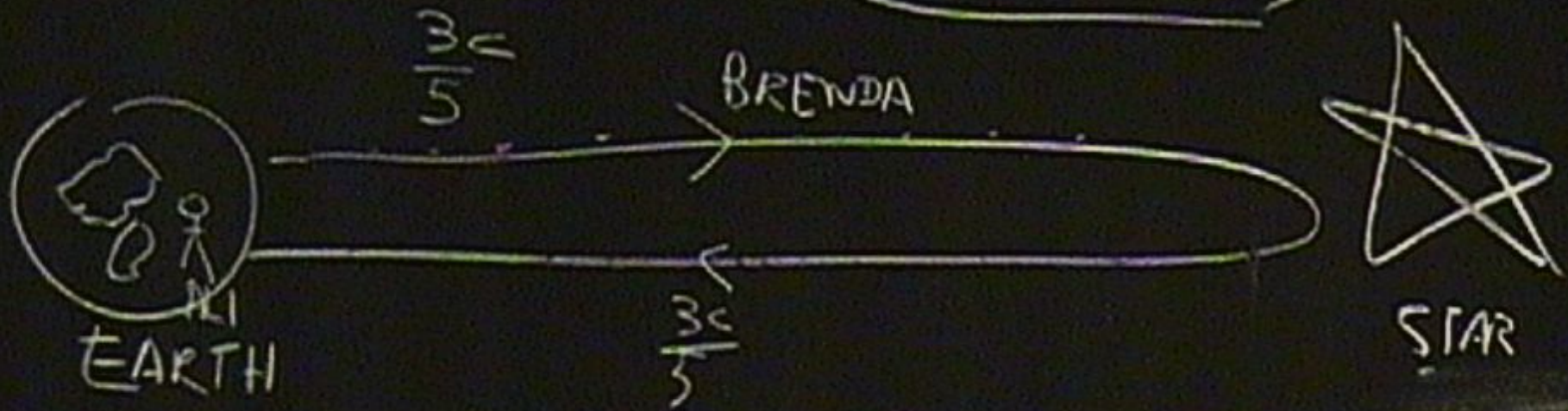

10 years to star

$$S^2 = (ct)^2 - (\Delta X)^2$$

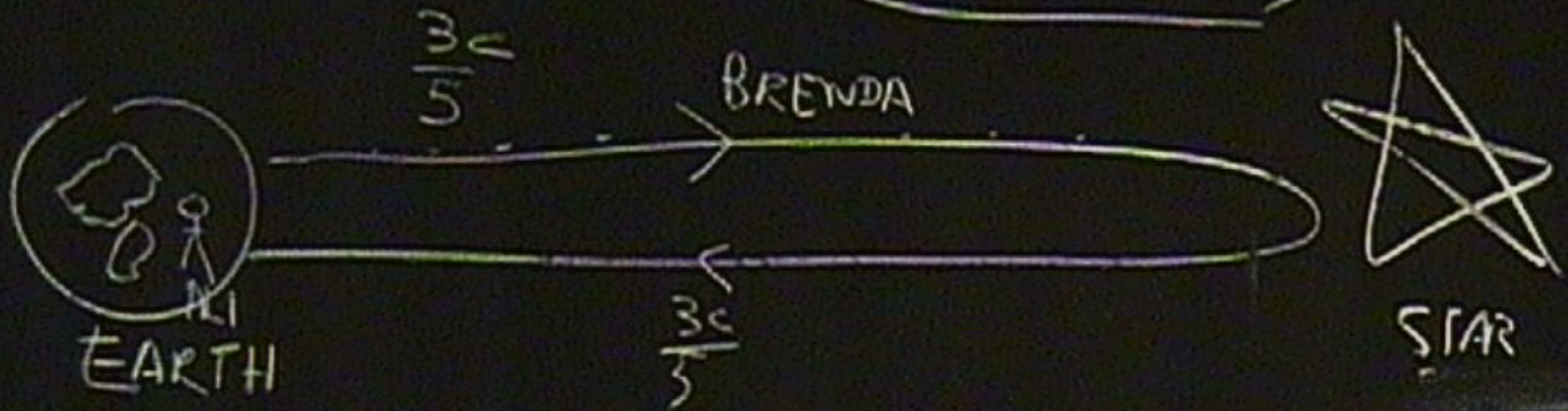

10 years to star

$$S^2 = (ct)^2 - (\Delta X)^2$$

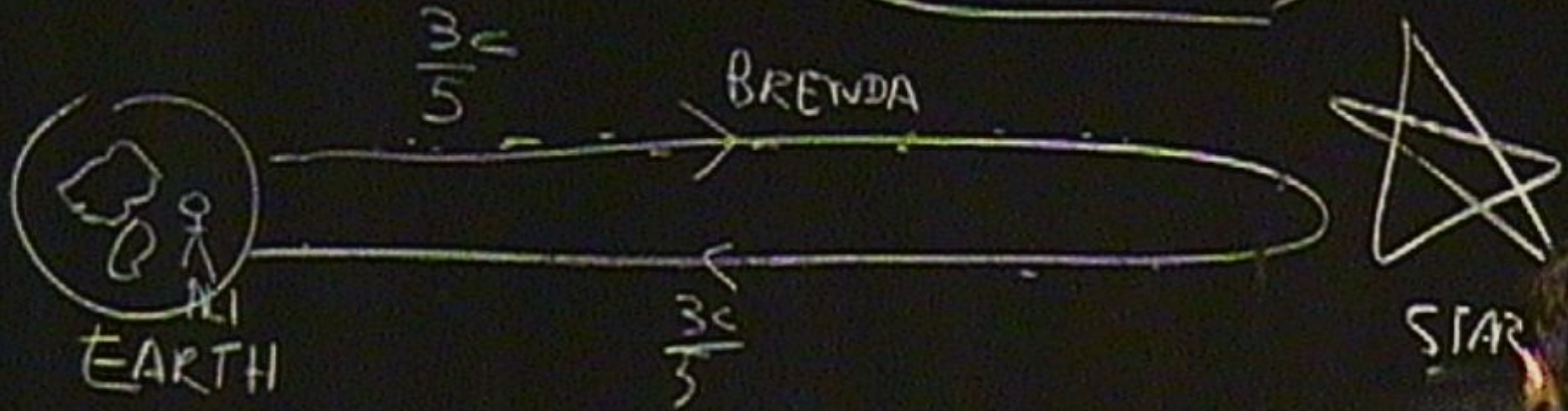

$$\gamma = \frac{1}{\sqrt{1 - \frac{v^2}{c^2}}}$$

ALI
Brenda

10 years to star

$$\Delta s^2 = (c\Delta t)^2 - (\Delta x)^2$$

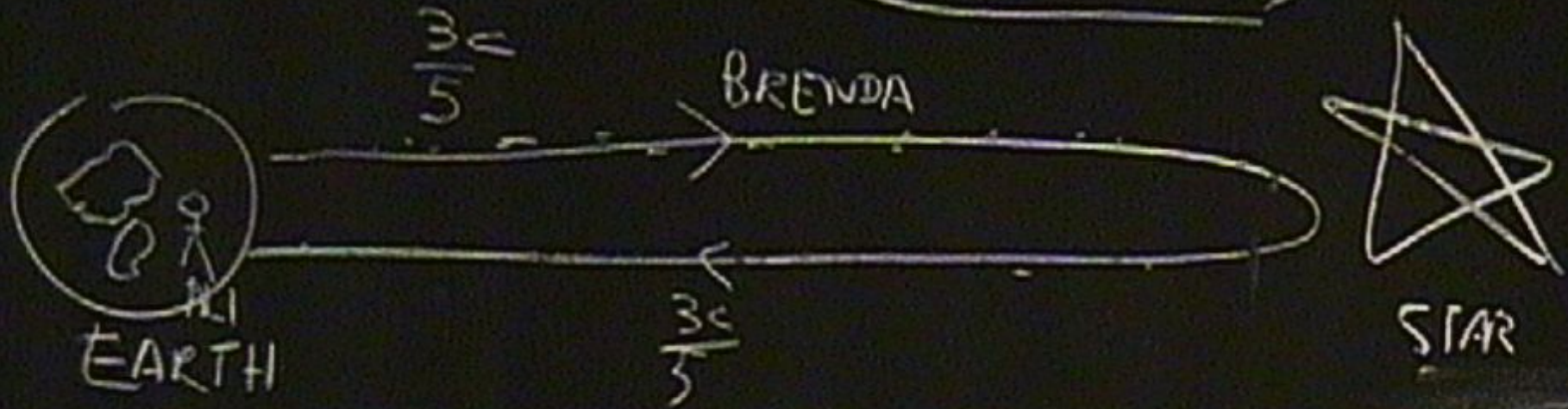

$$\gamma = \frac{1}{\sqrt{1 - \left(\frac{3c}{5}\right)^2}}$$

ALI	
Brenda	20 years
Ali	25 "

10 years to star

$$S^2 = (ct)^2 - (\Delta X)^2$$

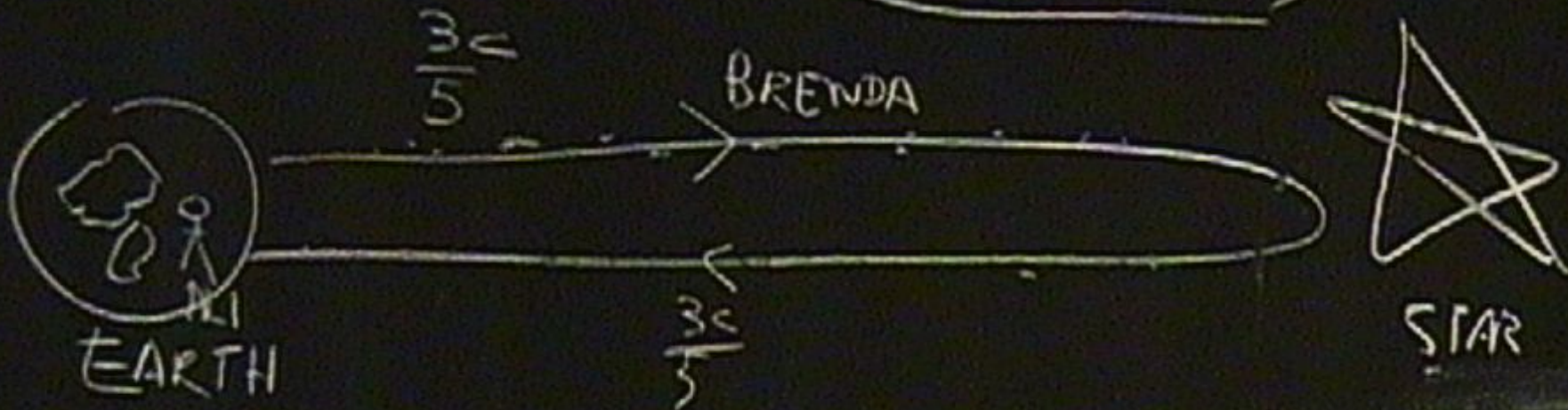

$$\gamma = \frac{1}{\sqrt{1 - \left(\frac{v}{c}\right)^2}}$$

ALI	
<hr/>	
Brenda	20 years
Ali	25 "

10 years to star

$$S^2 = (ct)^2 - (\Delta X)^2$$

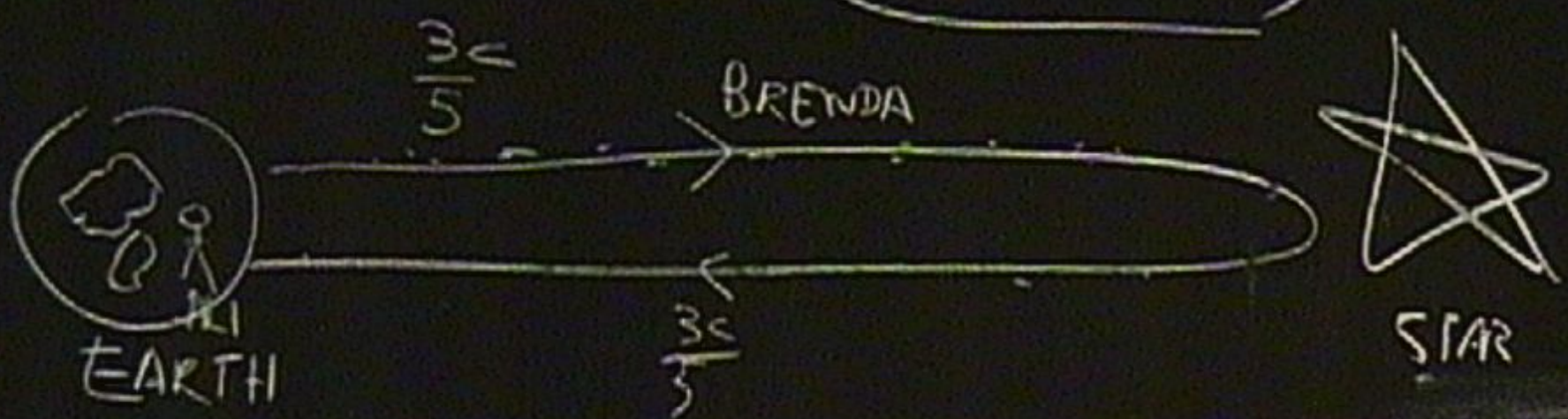

$$\gamma = \frac{1}{\sqrt{1 - \left(\frac{v}{c}\right)^2}}$$

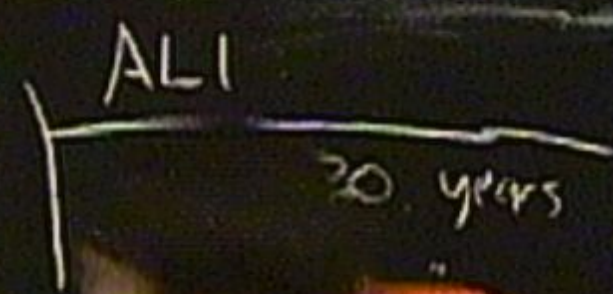

10 years to star

$$S^2 = (ct)^2 - (\Delta X)^2$$

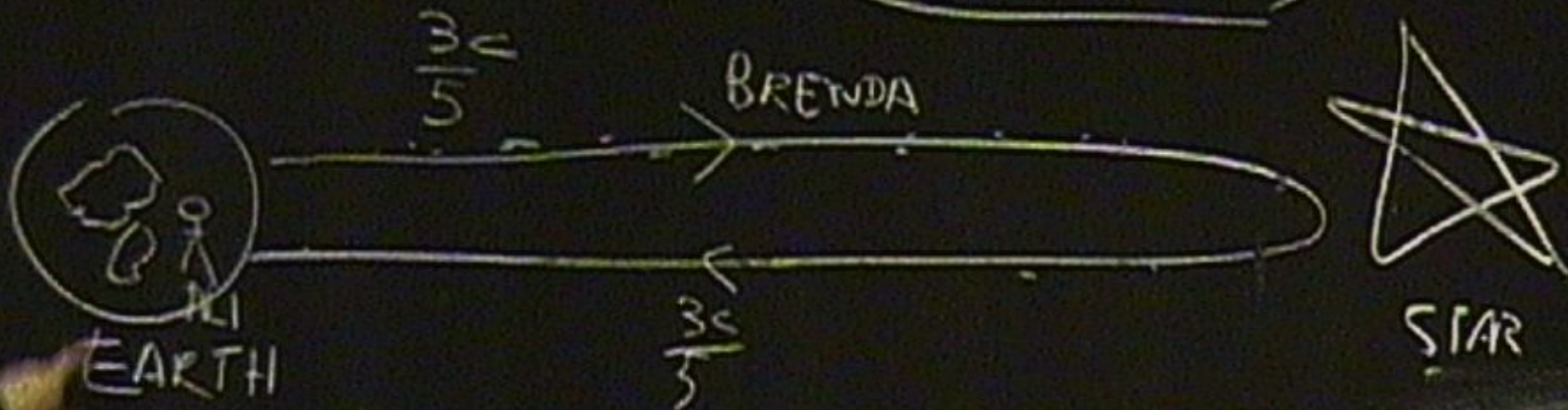

$$\gamma = \frac{1}{\sqrt{1 - \left(\frac{v}{c}\right)^2}}$$

ALI	
Brenda	20 years
Ali	25 "

10 years to star

$$S^2 = (ct)^2 - (\Delta X)^2$$

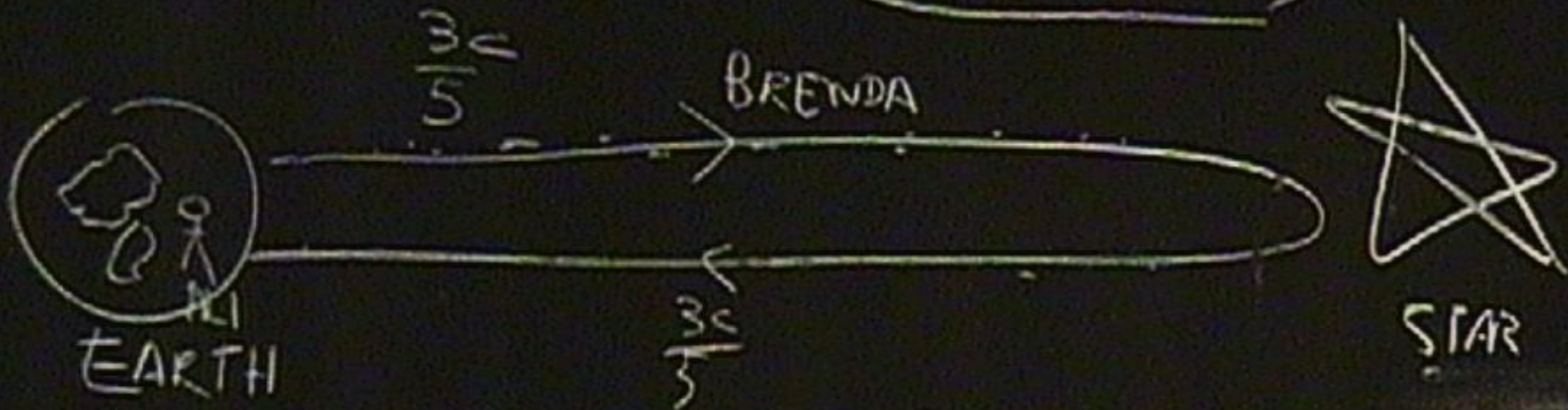

$$\gamma = \frac{1}{\sqrt{1 - \left(\frac{v}{c}\right)^2}}$$

BREND A	
B	25
A	20

ALI	
Brenda	20 years
Ali	25 "

10 years to star

$$S^2 = (ct)^2 - (dx)^2$$

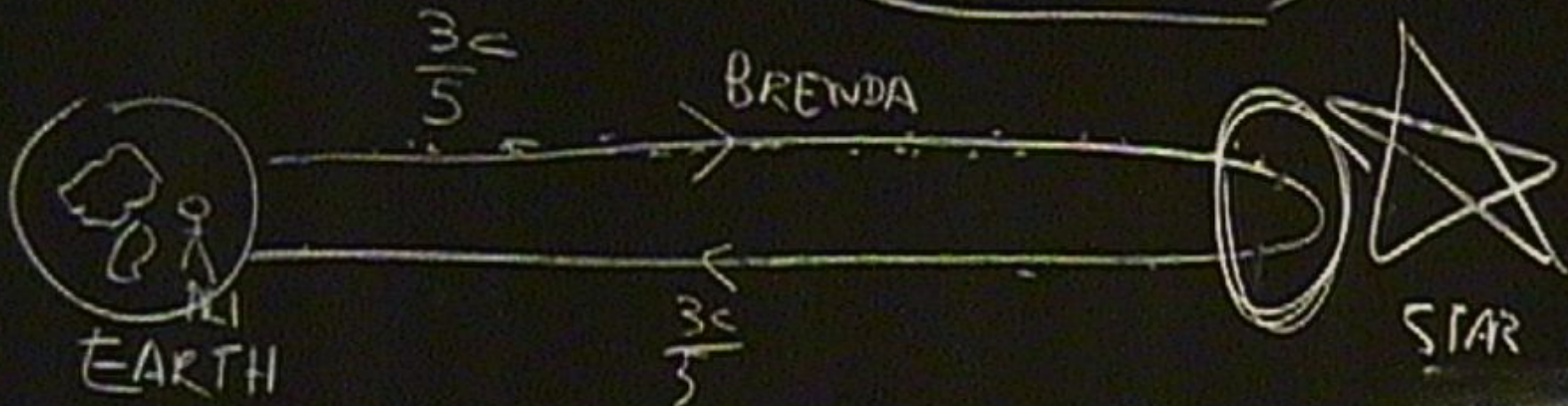

$$\gamma = \frac{1}{\sqrt{1 - \left(\frac{v}{c}\right)^2}}$$

BREND A
B: 25
A: 20

ALI
Brenda: 20 years
Ali: 25 "

Twin paradox

Consider two twins. One day, one of them decides to go on

What are the spacetime intervals for the two paths?

$$s = cT$$

$$s' = 2 \sqrt{\left(\frac{cT}{2}\right)^2 - d^2}$$

$$= cT \sqrt{1 - \left(\frac{2d}{cT}\right)^2}$$

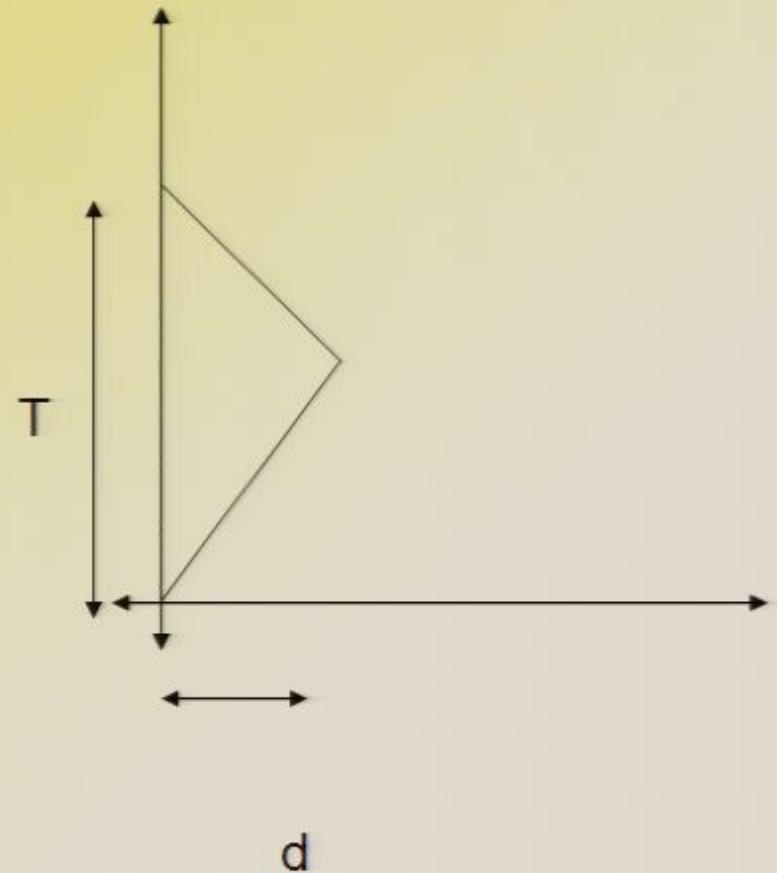

Twin paradox

Consider two twins. One day, one of them decides to go on

What are the spacetime intervals for the two paths?

$s=cT$

$$s' = 2\sqrt{\left(\frac{cT}{2}\right)^2 - d^2}$$

$$= cT\sqrt{1 - \left(\frac{2d}{cT}\right)^2}$$

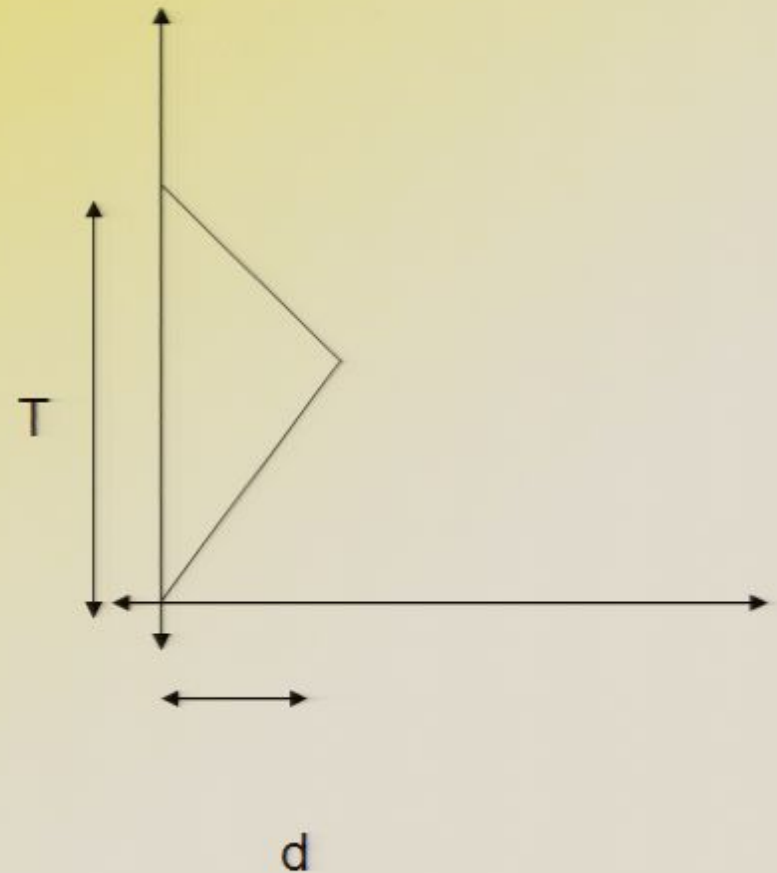

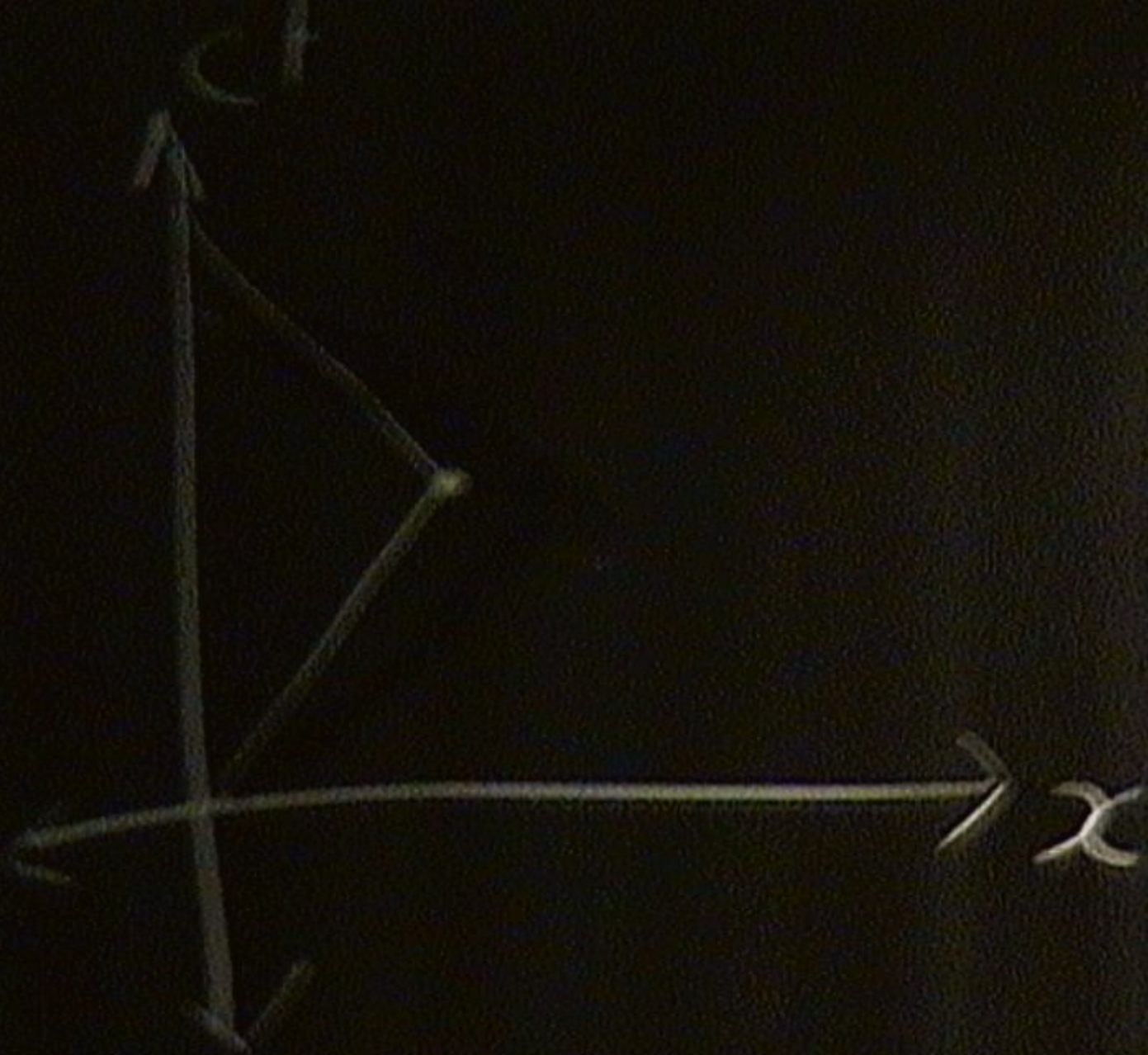

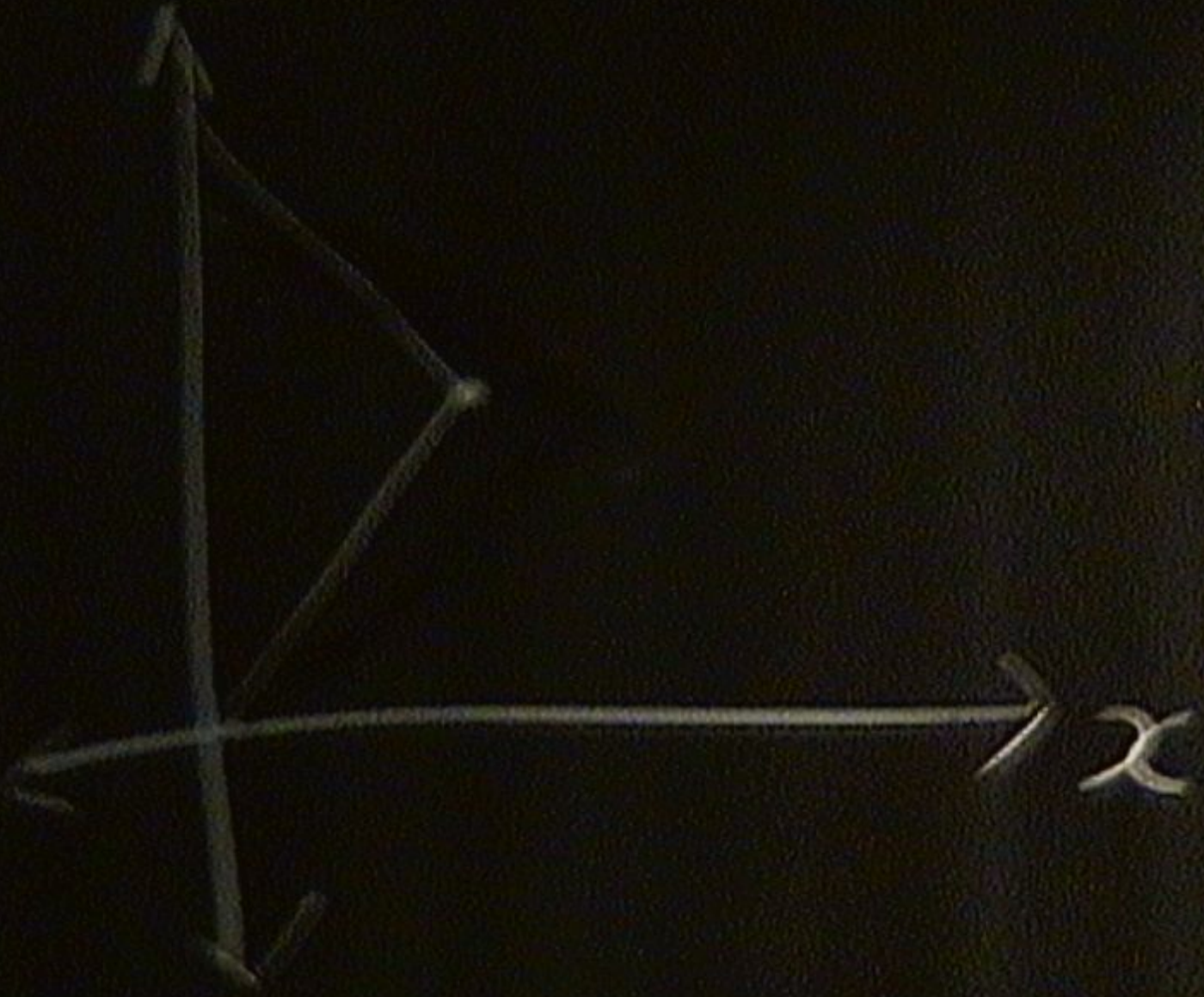

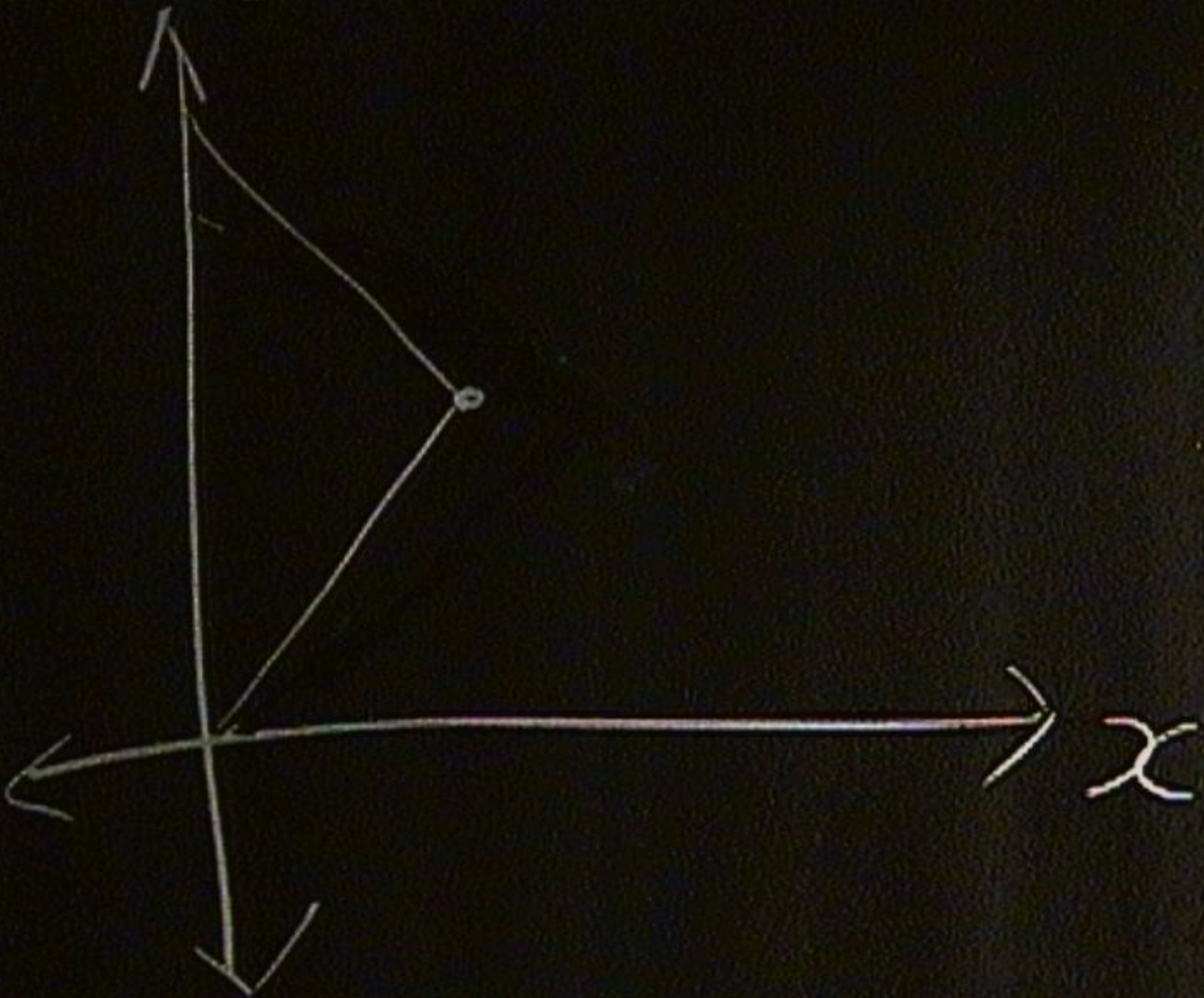



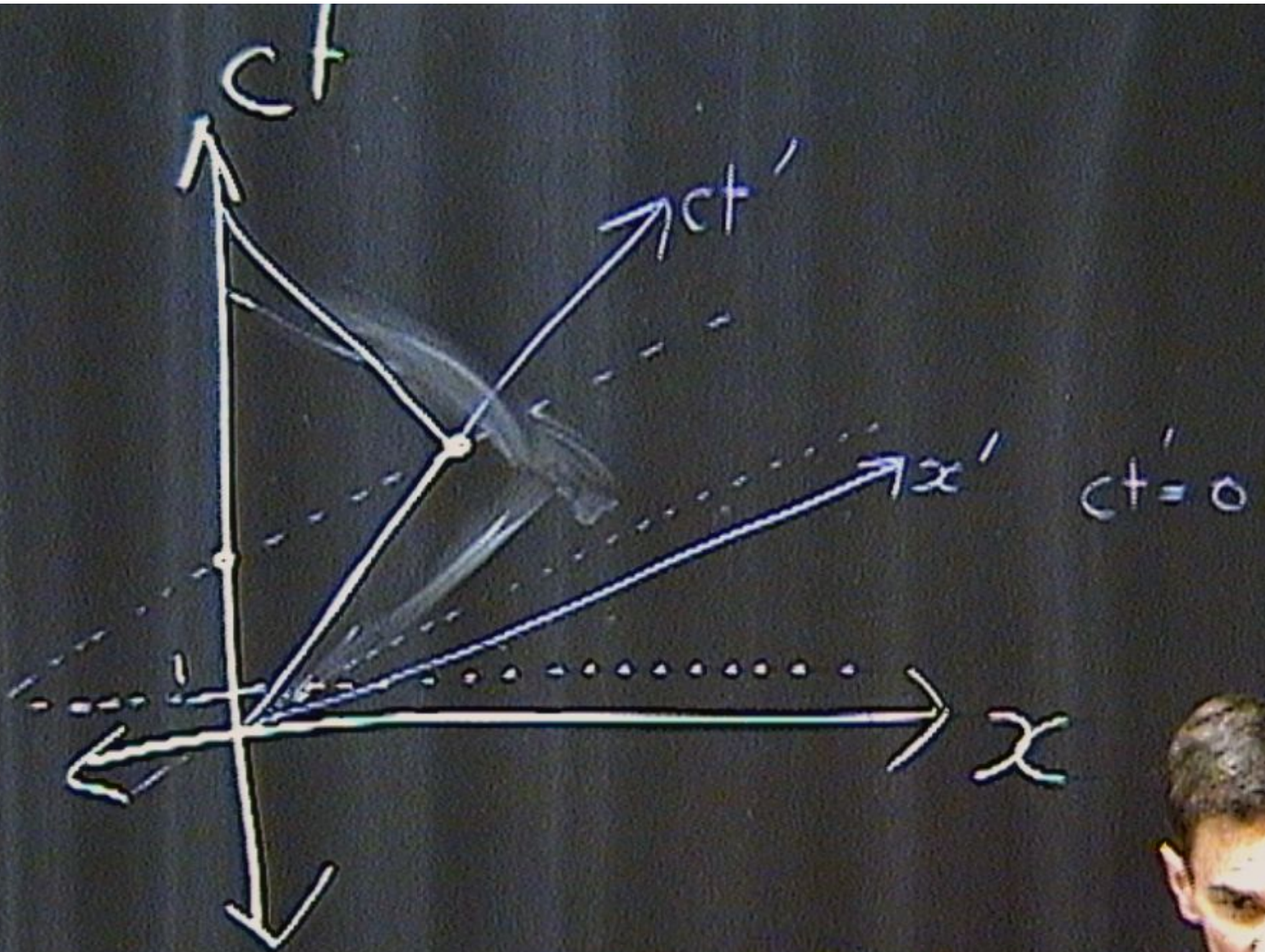

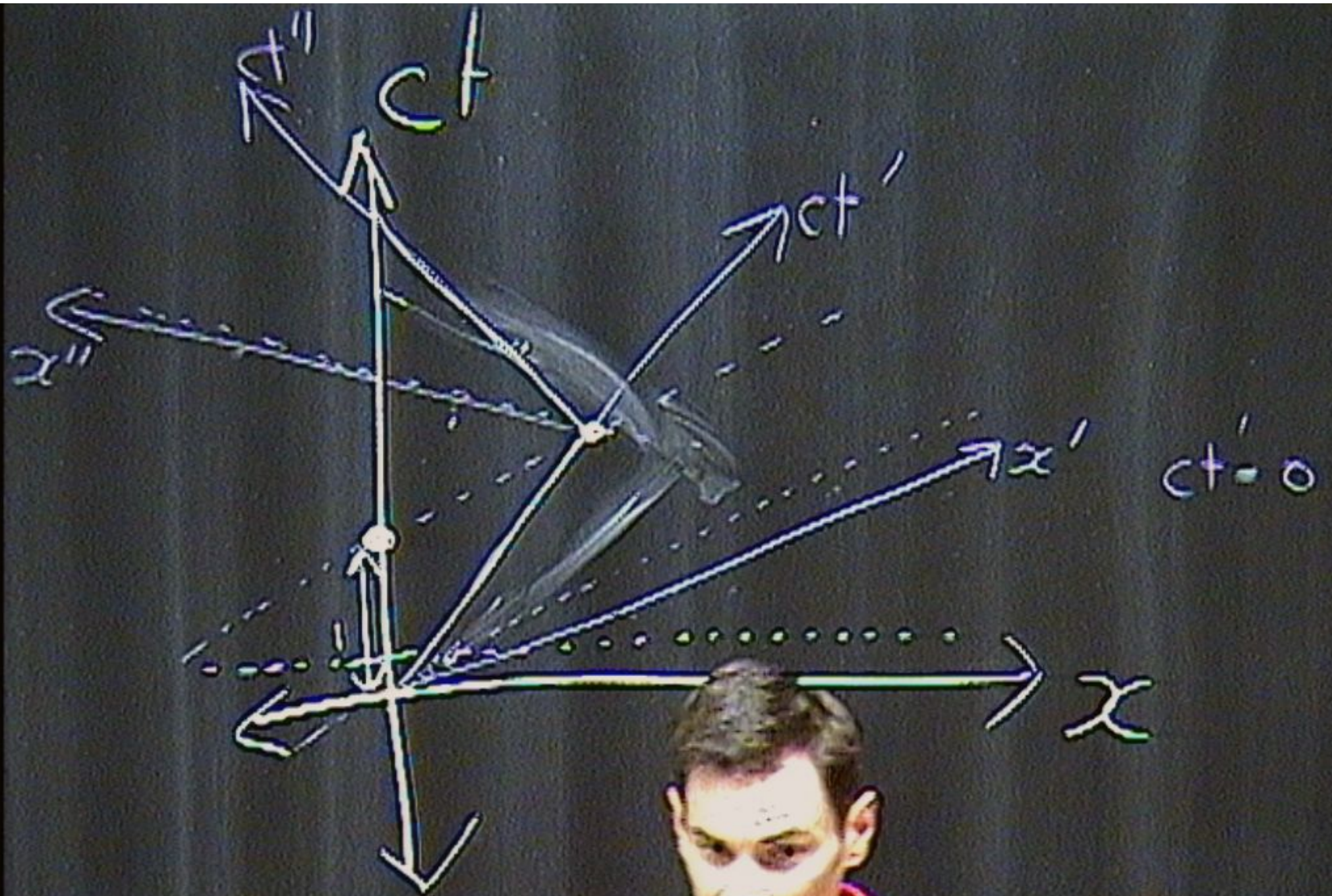

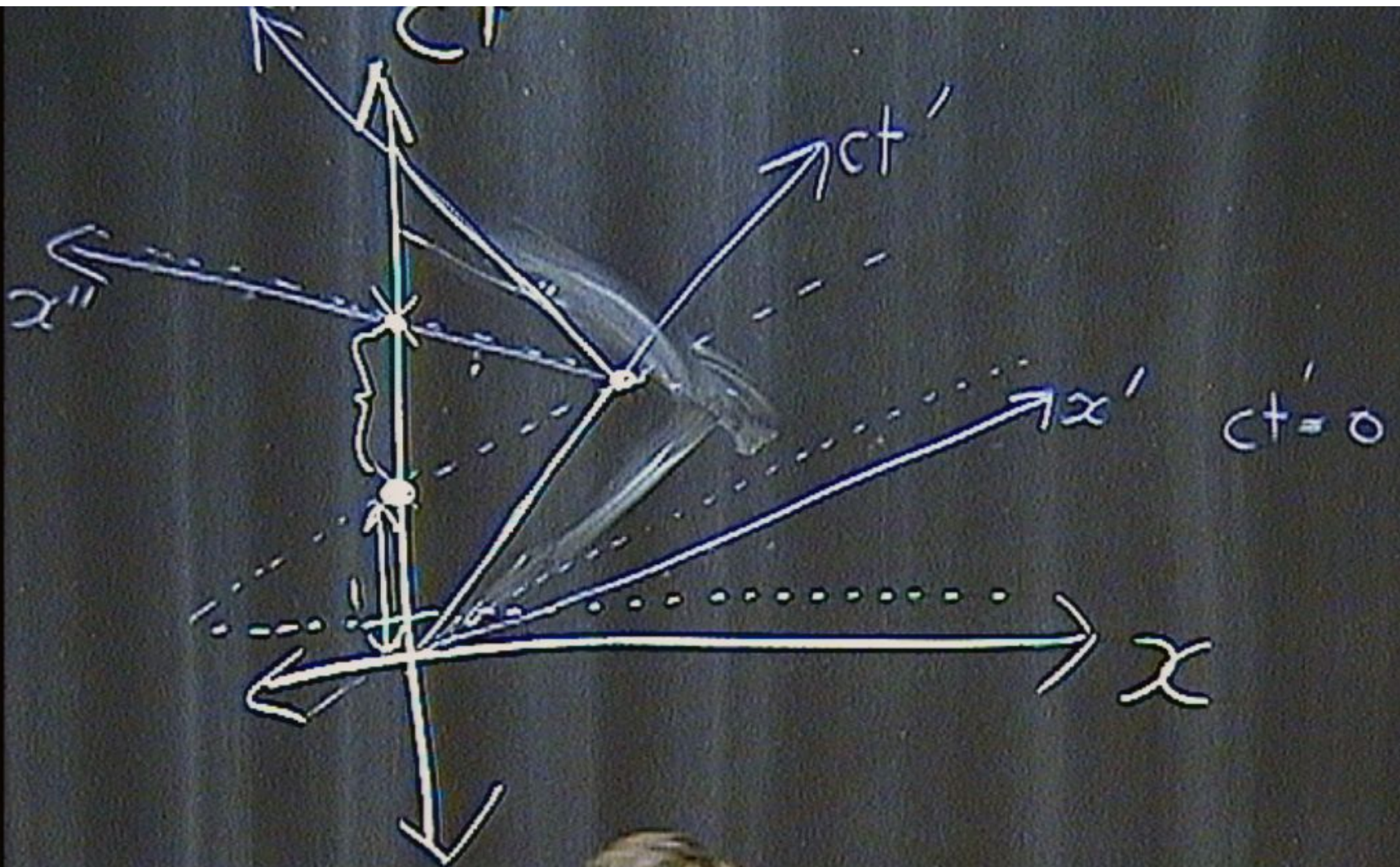

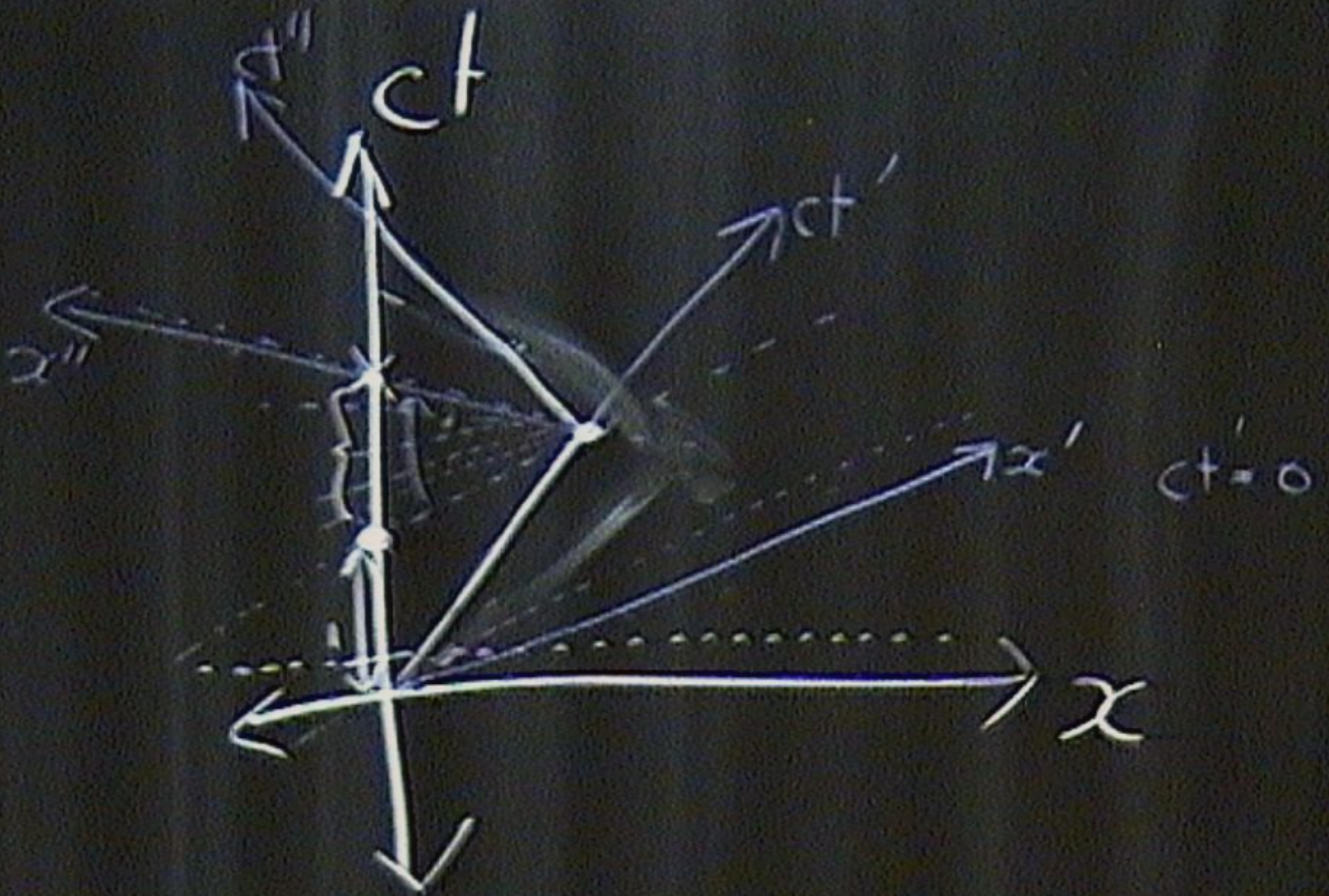

Twin paradox

Consider two twins. One day, one of them decides to go on

What are the spacetime intervals for the two paths?

$s=cT$

$$s' = 2\sqrt{\left(\frac{cT}{2}\right)^2 - d^2}$$

$$= cT\sqrt{1 - \left(\frac{2d}{cT}\right)^2}$$

